



Panasonic®

TV/DVD Combination Operating Instructions

Model No. **PV-20DF63/PV-27DF63**



- Initial Setup and Connection Procedures are on pages 10 to 11.



MULTI FORMAT PLAYBACK



*Ability to play back may depend on recording conditions.



As an ENERGY STAR® Partner, Matsushita Electric Corporation of America has determined that this product or product model meets the ENERGY STAR® guidelines for energy efficiency.

Please read these instructions carefully before attempting to connect, operate or adjust this product. Please save this manual. Spanish Quick Use Guide is included. (Guía para rápida consulta en español está incluida.)



This operating instruction book is designed for use with models PV-20DF63 and PV-27DF63. Illustrations in this manual show the PV-27DF63. Features may vary, so please read carefully.

For assistance, please call : 1-800-211-PANA(7262) or send e-mail to : consumerproducts@panasonic.com

Initial Setup

DVD Operation

TV Operation

Advanced Operation

For Your Information

LSQT0670B

Important Safeguards and Precautions

READ AND RETAIN ALL SAFETY AND OPERATING INSTRUCTIONS. HEED ALL WARNINGS IN THE MANUAL AND ON UNIT

INSTALLATION

1 POWER SOURCE CAUTION

Operate only from power source indicated on unit or in this manual. If uncertain, have your Electric Utility Service Company or Video Products Dealer verify your home power source.

2 POWER CORD PLUG

For safety, this unit has a polarized type plug (one wide blade), or a three-wire grounding type plug. Always hold the plug firmly and make sure your hands are dry when plugging in or unplugging the AC power cord.

Regularly remove dust, dirt, etc. on the plug.

POLARIZED PLUG CAUTION:

The plug fits into outlet only one way. If it cannot be fully inserted, try reversing it. If it still will not fit, have an electrician install the proper wall outlet. Do not tamper with the plug.

GROUNDING PLUG CAUTION:

The plug requires a three-hole grounding outlet. If necessary, have an electrician install the proper outlet. Do not tamper with the plug.

3 POWER CORD

To avoid unit malfunction, and to protect against electrical shock, fire or personal injury:

- Keep power cord away from heating appliances and walking traffic. Do not rest heavy objects on, or roll such objects over the power cord.
- Do not tamper with the cord in any way.
- An extension cord should have the same type plug (polarized or grounding) and must be securely connected.
- Overloaded wall outlets or extension cords are fire hazards.
- Frayed cords, damaged plugs, and damaged or cracked wire insulation are hazardous and should be replaced by a qualified electrician.

4 DO NOT BLOCK VENTILATION HOLES

Ventilation openings in the cabinet release heat generated during operation. If blocked, heat build-up may result in a fire hazard or heat damage to discs.

For your protection:

- Never cover ventilation slots while unit is ON, or operate unit while placed on a bed, sofa, rug, or other soft surface.
- Avoid built-in installation, such as a book case or rack, unless properly ventilated.

5 AVOID EXTREMELY HOT LOCATIONS OR SUDDEN TEMPERATURE CHANGES

Do not place unit over or near a heater or radiator, in direct sunlight, inside closed vehicles, in high temperature [over 95 °F (35 °C)], or in over 75% humidity. If unit is suddenly moved from a cold place to a warm one, moisture may condense in unit and on the disc causing damage. Never subject unit to vibration, impact, or place it so that the surface is tilted as internal parts may be seriously damaged.

6 TO AVOID PERSONAL INJURY

- Never place unit on support or stand that is not firm, level, and adequately strong. The unit could fall causing serious injury to a child or adult and damage to the unit.
- Move any appliance and cart combination with care. Quick stops, excessive force, and uneven surfaces may cause objects to overturn.
- Carefully follow all operating instructions.



OUTDOOR ANTENNA INSTALLATION

1 SAFE ANTENNA AND CABLE CONNECTION

An outside antenna or cable system must be properly grounded to provide some protection against built up static charges and voltage. Section 810 of the National Electrical Code, ANSI/NFPA 70 (in Canada, part 1 of the Canadian Electrical Code) provides information regarding proper grounding of the mast and supporting structure, grounding of the lead-in wire to an antenna discharge unit, size of grounding conductors, location of antenna discharge unit, connection to grounding electrodes, and requirements for the grounding electrode.

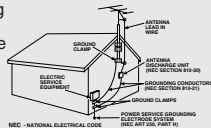

2 KEEP ANTENNA CLEAR OF HIGH VOLTAGE POWER LINES OR CIRCUITS

Locate an outside antenna system well away from power lines and electric light or power circuits so it will never touch these power sources should it ever fall. When installing antenna, absolutely never touch power lines, circuits or other power sources as this could be fatal.

USING THE UNIT

Before unit is brought out of storage or moved to a new location, refer again to the INSTALLATION section of these safeguards.

1 KEEP UNIT WELL AWAY FROM WATER OR MOISTURE, such as vases, sinks, tubs, etc.

2 IF EXPOSED TO RAIN, MOISTURE, OR STRONG IMPACT, unplug unit and have it inspected by a qualified service technician before use.

3 ELECTRICAL STORMS

During a lightning storm, or before leaving unit unused for extended periods of time, disconnect all equipment from the power source as well as the antenna and cable system.

4 WHEN UNIT IS PLUGGED IN

- DO NOT OPERATE IF:
 - liquid has spilled into unit.
 - unit was dropped or otherwise damaged.
 - unit emits smoke, odours, or noises.
- Immediately unplug unit, and have it inspected by a service technician to avoid potential fire and shock hazards.
- Never drop or push any object through openings in unit. Touching internal parts may cause electric shock or fire hazard. Do not put any foreign object on the tray.
- Keep magnetic objects, such as speakers, away from unit to avoid electrical interference.

5 USING ACCESSORIES

Use only accessories recommended by the manufacturer to avoid risk of fire, shock, or other hazards.

6 CLEANING UNIT

Unplug unit. Use a clean, dry, chemically untreated cloth to gently remove dust or debris. DO NOT USE cleaning fluids, aerosols, or forced air that could over-spray, or seep into unit and cause electrical shock. Any substance, such as wax, adhesive tape, etc. may mar the cabinet surface. Exposure to greasy, humid, or dusty areas may adversely affect internal parts.

SERVICE

1 DO NOT SERVICE PRODUCT YOURSELF

If, after carefully following detailed operating instructions, the unit does not operate properly, do not attempt to open or remove covers, or make any adjustments not described in the manual. Unplug unit and contact a qualified service technician.

2 REPLACEMENT OF PARTS

Make sure the service technician uses only parts specified by the manufacturer, or have equal safety characteristics as original parts. The use of unauthorized substitutes may result in fire, electric shock, or other hazards.

3 SAFETY CHECK AFTER SERVICING

After unit is serviced or repaired, request that a thorough safety check be done as described in the manufacturer's service literature to ensure video unit is in safe operating condition.

Safety Precautions/Mesures de sécurité

- Warning :** To prevent fire or shock hazard, do not expose this equipment to rain or moisture.
- Caution :** To prevent electric shock, match wide blade of plug to wide slot, fully insert.
- Avertissement :** Afin de prévenir tout risque d'incendie ou de chocs électriques, ne pas exposer cet appareil à la pluie ou à une humidité excessive.
- Attention :** Pour éviter les chocs électriques, introduire la lame la plus large de la fiche dans la borne correspondante de la prise et pousser jusqu'au fond.
- FCC WARNING :** Any unauthorized changes or modifications to this equipment would void the user's authority to operate.

This television receiver provides display of television closed captioning.

CAUTION:

UNIT IS A CLASS I LASER PRODUCT. HOWEVER THIS UNIT USES A VISIBLE LASER BEAM WHICH COULD CAUSE HAZARDOUS RADIATION EXPOSURE IF DIRECTED. BE SURE TO OPERATE THE UNIT CORRECTLY AS INSTRUCTED. WHEN THIS UNIT IS PLUGGED TO THE WALL OUTLET, DO NOT PLACE YOUR EYES CLOSE TO THE OPENING OF THE DISC TRAY AND OTHER OPENINGS TO LOOK INTO THE INSIDE OF THIS UNIT. USE OF CONTROLS OR ADJUSTMENTS OR PERFORMANCE OF PROCEDURES OTHER THAN THOSE SPECIFIED HEREIN MAY RESULT IN HAZARDOUS RADIATION EXPOSURE. DO NOT OPEN COVERS AND DO NOT ATTEMPT TO REPAIR THE UNIT YOURSELF. REFER SERVICING TO QUALIFIED PERSONNEL.

CAUTION:

LASER RADIATION
WHEN OPEN. DO NOT
STARE INTO BEAM.

ATTENTION:

RAYONNEMENT LASER
EN CAS D'OUVERTURE.
NE PAS REGARDER
DANS LE FAISCEAU.

(Inside of product)

FCC NOTICE:

This equipment has been tested and found to comply with part 15 of the FCC Rules. These limits are designed to provide reasonable protection against harmful interference when operated in a residential environment. If this equipment does cause interference to radio or television reception, which can be determined by turning the equipment off and on, use the equipment in another location and/or utilize an electrical outlet different from that used by the receiver. If necessary, consult the dealer or an experienced radio/TV technician for help. You may find the booklet, "Something About Interference" available from FCC local regional offices helpful.

This product utilizes both a Cathode Ray Tube (CRT) and other components that contain lead. Disposal of these materials may be regulated in your community due to environmental considerations. For disposal or recycling information please contact your local authorities, or the Electronics Industries Alliance: <<http://www.eiae.org>>

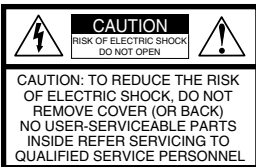

This symbol warns the user that uninsulated voltage within the unit may have sufficient magnitude to cause electric shock. Therefore, it is dangerous to make any kind of contact with any inside part of this unit.

This symbol alerts the user that important literature concerning the operation and maintenance of this unit has been included. Therefore, it should be read carefully in order to avoid any problems.

Region Management Information

This unit is designed and manufactured to respond to the Region Management Information that is recorded on a DVD disc. If the Region number described on the DVD disc does not correspond to the Region number of this unit, this unit cannot play this disc.

- The region number of this player is "1."
- The player will play DVD-Video marked with labels containing "1" or "ALL."

Example:



Before Using

Congratulations

On your purchase of one of the most sophisticated and reliable products on the market today. Used properly, it will bring you and your family years of enjoyment. Please fill in the information below. The serial number is on the tag located on the back of your unit.

Date of Purchase _____

Dealer Purchased From _____

Dealer Address _____

Dealer Phone No. _____

Model No. _____

Serial No. _____

Accessories

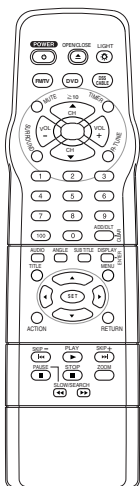

Remote Control
LSSQ0346

Batteries 2 "AA"

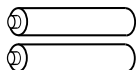

To order accessories,
call toll free
1-800-332-5368.

Loading the Batteries

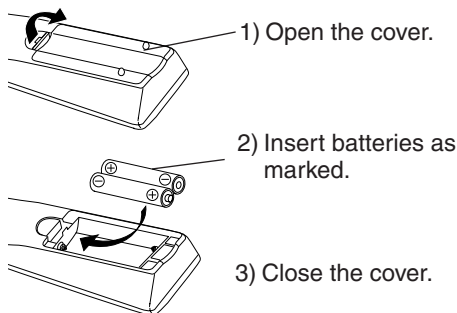

Battery replacement caution

- Do not mix old and new batteries.
- Do not mix alkaline with manganese batteries.

Features for a Quality Picture

Pure Flat Picture Tube

This unit is equipped with pure flat Picture Tube.

Apparatus Claims of U.S. Patent Nos. 4,631,603, 4,577,216, 4,819,098, and 4,907,093, licensed for limited viewing uses only.

This product incorporates copyright protection technology that is protected by method claims of certain U.S. Patents and other intellectual property rights owned by Macrovision Corporation and other rights owners. Use of this copyright protection technology must be authorized by Macrovision Corporation, and is intended for home and other limited viewing uses only unless otherwise authorized by Macrovision Corporation. Reverse engineering or disassembly is prohibited.

Table of Contents

TV	Important Safeguards and Precautions	2
	Safety Precautions/Mesures de sécurité.....	3
	Before Using	4
	Information (Unit, Disc).....	6
	Location of Controls	8
	Initial Setup (Ready to Play)	10
	Reset Language, Channels, Clock, Time Zone Adjust.....	12
	Audio Connections.....	14

Initial Setup

DVD	Basic DVD Operation	16
------------	---------------------------	----

DVD Operation

TV	TV Operation	18
	MTS Broadcast/TV Stereo System.....	19
	Closed Caption System	20
	TV Timer Features	22
	On-Screen Display (OSD)	23
	FM Radio	24

TV Operation

TV	Cable Box Universal Remote Control Feature.....	26
	Special Features	28
	V-Chip Control Feature	30
	Video/Audio Menu	34
	Video/Audio Adjustment.....	35

Advanced Operation

DVD	Disc Operation	36
	DVD Operation using On-Screen Displays	41
	MP3/WMA/JPEG Playback Operation	44
	DVD Lock Feature.....	47
	Settings for DVD Operation.....	48
	Language Code List	51

TV	Before Requesting Service.....	52
	Warning and Instruction Displays	54
	Spanish Quick Use Guide/Guía para rápida consulta.....	55
	Limited Warranty	62
	Customer Services Directory	63
	Index	64

For Your Information

Information (Unit, Disc)







Specifications

Display	
Picture Tube	20 inch diagonal pure flat Picture Tube (PV-20DF63) 27 inch diagonal pure flat Picture Tube (PV-27DF63)
Tuner	
Broadcast Channels	VHF 2 ~ 13, UHF 14 ~ 69
CABLE Channels	Midband A through I (14 ~ 22) Superband J through W (23 ~ 36) Hyperband AA ~ EEE (37 ~ 64) Lowband A-5 ~ A-1 (95 ~ 99) Special CABLE channel 5A (01) Ultradband 65 ~ 94, 100 ~ 125
FM Radio	
Band Range	87.5 MHz ~ 108.1 MHz
General	
Power Source	120 V AC, 60 Hz
Power Consumption	Power On Approx. 113 W (PV-20DF63) Approx. 146 W (PV-27DF63)
	Power Off Approx. 3.5 W
Television System	EIA Standard NTSC color
Speaker	2 pieces 5 W
Operating Temperature	5 °C ~ 35 °C (41 °F ~ 95 °F)
Operating Humidity	10 % ~ 75 %
Weight	28 kg (61.7 lbs.) (PV-20DF63) 47 kg (103.6 lbs.) (PV-27DF63)
Dimensions (W x H x D)	604 mm (23-13/16") x 523 mm (20-9/16") x 503 mm (19-3/4") (PV-20DF63) 760 mm (29-7/8") x 651 mm (25-5/8") x 503 mm (19-3/4") (PV-27DF63)
Discs played	
DVD disc (DVD-Video, DVD-R)	12 cm (5") single-sided, single-layer 12 cm (5") single-sided, double-layer 12 cm (5") double-sided, double-layer (one layer per side) 8 cm (3") single-sided, single-layer 8 cm (3") single-sided, double-layer 8 cm (3") double-sided, double-layer (one layer per side)
Compact disc (CD-DA, VIDEO CD, CD-R, CD-RW)	5" (12 cm) disc 3" (8 cm) disc
MP3, WMA, JPEG	
Digital audio output	
Optical digital output	Optical connector
Pickup	
Wavelength	655 nm (DVD) 790 nm (Video CD/CD) Laser power: CLASS II

Note

- Designs and specifications are subject to change without notice.

Discs that can be played

Disc type	Disc Logo	Disc formats supported by this unit
DVD-Video		• DVD-Video format
		
DVD-R		• DVD-Video formatted discs (finalized*) It may not be possible to play these discs in all cases due to the type of disc or condition of the recording.
Video CD		• Video-CD format
CD-DA		• CD-DA format
CD-R		• CD-DA format • Video-CD format • MP3/WMA/JPEG file and finalized*.
CD-RW		

- Discs played 8 cm (3") or 12 cm (5")
- * A process that allows play on compatible equipment.

Discs which cannot be played with this unit

- DVD with Region No. other than "1" or "ALL"
- DVD of PAL system
- DVD-ROM
- DVD-AUDIO
- DVD-RW
- DVD+RW
- CD-ROM
- CDV
- CVD
- CD-G
- CD-TEXT
- SACD
- Photo-CD

Definition of Terms

Angle

Some DVD discs feature scenes simultaneously shot from different angles. The ANGLE button can be used to view the scene from different angles. (ANGLE Indicator lights up on the unit when a scene recorded at different angles is detected.)

Chapter Number

Titles are subdivided into numbered sections. You can quickly search for a favorite scene using these numbers.

DVD

A high-density optical disc on which high-quality pictures and sound have been digitally recorded. DVD incorporates new video compression technology (MPEG II) and high-density recording technology which allow entire movies to be recorded with incredible playback quality.

Playback Control

With Video CD (version 2.0), scenes or information may be selected for viewing or listening from an interactive menu that appears on the TV screen.

Subtitles

Written dialogue which appears at the bottom of the screen.

Time Number

The elapsed play time from the start of a disc or title. Use to quickly find scenes. (May not work with some discs.)

Title Number

For DVD discs with two or more titles, the title is numbered as title 1, title 2, etc.

Track Number

Numbers assigned to tracks on Video CDs and CDs to allow specific tracks to be quickly located.

Video CD

CD containing picture and sound with same quality level as video tape. This unit also supports Video CDs with playback control (version 2.0).

Disc Handling

Handling precautions

- Sticking a label on the disc may impair DVD-R playback.
- Do not attach sticker to discs. (Do not use discs with exposed adhesive from tape or left over peeled-off stickers.)
- Only hold disc by edges as shown. Fingerprints, dirt, and scratches can cause skipping and distortion.
- Do not write on label side of disc.
- Never use record cleaning sprays, benzine, thinner, static electricity prevention liquids, or any other solvent.
- Be careful not to drop or bend disc.
- Do not place more than 1 disc on disc tray.
- Do not try to close disc tray when disc is not properly placed.
- Always store discs in their proper cases when not in use.

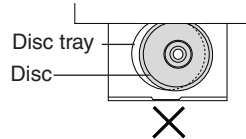
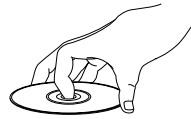

To clean disc surface

With a soft, damp (water only) cloth, gently wipe from the center hole to the outer edge as shown below. (Wiping in a circular pattern will scratch the surface.)

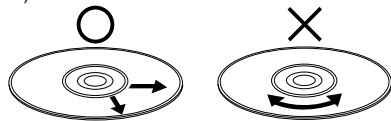

If disc is brought from a cold to a warm environment, moisture may form on the disc

Wipe away moisture with a soft, dry, lint-free cloth before using disc. (See above.)

Improper disc storage

Discs could be damaged if stored or left in areas:

- exposed to direct sunlight.
- that are humid or dusty.
- near heat (i.e. heater, radiator, etc.).

If the disc cannot be removed,

First unplug unit.

Then, prepare a rigid wire (e.g. an extended paper clip, etc.) and, applying moderate force, insert it straight into the hole at the base of the tray. The tray will eject a little. Now, pull the tray all the way out and remove the disc.

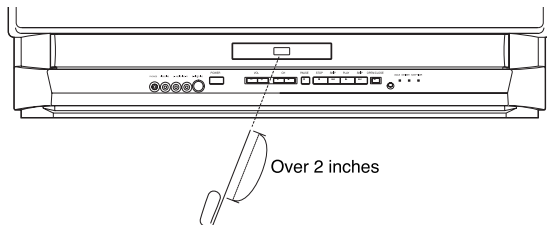

Location of Controls

Remote Control Buttons

OPEN/CLOSE

Opens or closes the disc tray.

POWER

Turns the unit on or off.

FM/TV

Sets to TV mode.
Receives FM radio signal.

MUTE

Mutes the sound instantly.

CHANNEL UP/DOWN

Selects a channel.

SURROUND

Creates a deeper, 3-D sound effect.

NUMBER Keys

Selects a channel directly.

ANGLE

Selects the desired angle in DVD mode.

AUDIO

Selects the desired audio mode.

TITLE

Selects the desired title by number on some DVDs.

SELECT $\blacktriangle\blacktriangleright\blacktriangleleft$

Controls navigation around on-screen menu.

ACTION

Displays Main Menu.

SET

Sets a selected menu.

SKIP- $\blacktriangleleft\blacktriangleleft$

Skips back one chapter or track.
Goes to previous menu screen.

PAUSE

Pauses picture in Play mode and frame advance picture in Still mode.

PLAY

Begins playback.

SLOW/SEARCH $\blacktriangleleft\blacktriangleleft$

Decreases slow motion speed in Still mode.
Reverses rapid scene search in Play mode.

DVD

Sets to DVD mode.

LIGHT

See below.

DSS/CABLE

Set the remote to control some basic DSS or Cable box functions.

TIMER

Sets ON TIMER or SLEEP TIMER.

VOLUME UP/DOWN

Adjusts volume.

RAPID TUNE

Displays the last channel you were watching.

ADD/DELETE/CLEAR

Adds or deletes a channel.
Cancels an item on the screen.

SUB TITLE

Selects a different subtitle language.

DISPLAY/ENTER

Displays the TV status and clock.
In DVD mode, displays disc and unit information.
In DSS or CABLE mode, it may be necessary after channel selection.

MENU

Displays DVD menu.

RETURN

Returns to Menu screen.

SKIP+ $\blacktriangleright\blacktriangleright$

Skips one chapter or track.
Goes to next menu screen.

ZOOM

Enlarges specific portions of picture.

STOP

Stops playback.

SLOW/SEARCH $\blacktriangleright\blacktriangleright$

Increases slow motion speed in Still mode.
Forwards rapid scene search in Play mode.

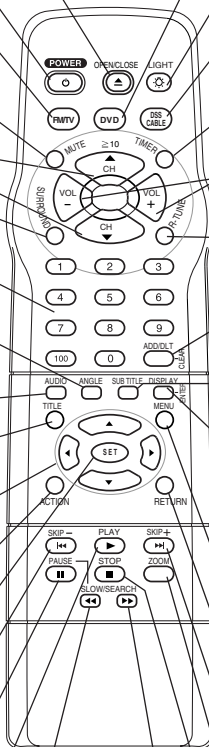

Note

When LIGHT is pressed, (FM/TV, DVD, DSS/CABLE, CH UP/DOWN, VOL +/-) buttons will light for 5 seconds for easy button location. If no button is pressed in 5 seconds, the light goes out to conserve the batteries.

Front View of the unit and Indicators

<Model PV-27DF63 unit shown>

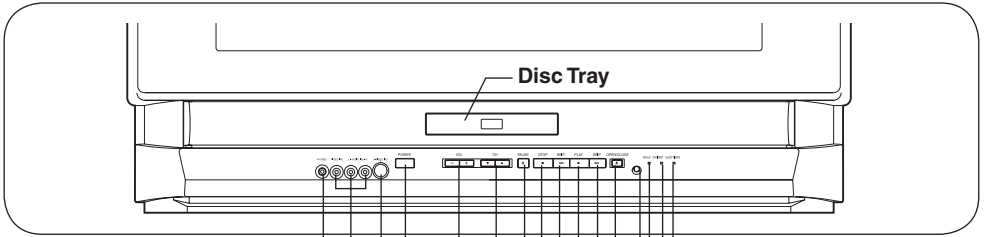

Phones Jack

Connect an earphone or headphones.

Audio/Video Input Connector 2 (LINE 2)

Connect from other component.

S-Video Input Connector 2 (LINE 2)

Connect from other component with S-Video.

POWER

Turns the unit on or off.

VOLUME UP/DOWN

Adjusts volume.

CHANNEL UP/DOWN

Selects a channel.

PAUSE

Pauses picture in Play mode and frame advance picture in Still mode.

STOP

Stops playback.

SLEEPTIMER Indicator

Lights when the Sleep-Timer is set.

ON TIMER Indicator

Lights when the On-Timer is set.

ANGLE Indicator

Lights when a scene recorded at a different angles is detected.

Remote Sensor

OPEN/CLOSE

Opens or closes the disc tray.

SKIP ►►►

Skips one chapter or track. Goes to next menu screen.

PLAY

Begins playback.

SKIP ◀◀◀

Skips back one chapter or track. Goes to previous menu screen.

Rear View of the unit

<Model PV-27DF63 unit shown>

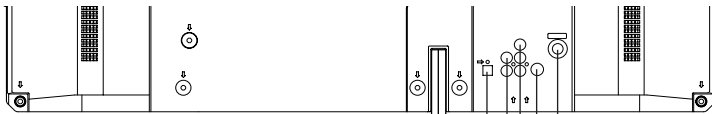

AC Power Plug

When plugged into an AC outlet, this unit consumes 3.5 W of electric power in OFF condition.

Optical digital audio output connector

Connect to Dolby Digital decoder or dts decoder. For details, see page 14.

Audio Output Connector (L/R)

Connect to other component.

VHF/UHF Antenna Input Terminal

In from your Antenna or Cable.

S-Video Input Connector 1 (LINE 1)

Connect from other component with S-Video.

Audio/Video Input Connector 1 (LINE 1)

Connect from other component.

Initial Setup (Ready to Play)

Please make all cable or antenna connections before powering on.

Connections

For ANT./Cable

Connect the cable from Antenna/Cable to the VHF/UHF terminal on the unit.

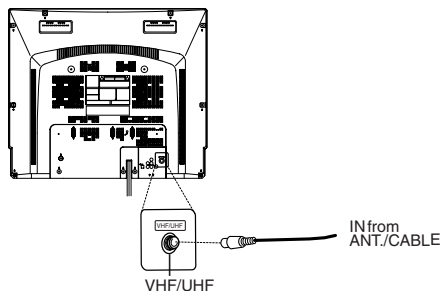

For DSS/Cable Box

Connect the OUT jack on your cable box to the VHF/UHF terminal on the unit with a RF cable.

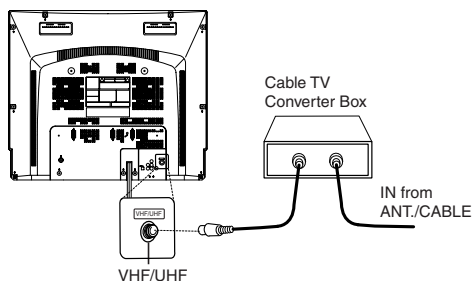

WARNING

Overtightening "Nut type" RF coaxial cables may damage jacks. Finger tighten only.

Initial Setup (Ready to Play)

1 Plug the unit power cord into an AC wall outlet.

2 Press **POWER*** on the remote or unit. The unit comes on and auto channel and clock set starts.

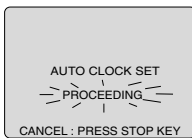
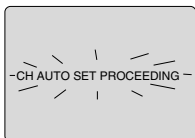

- If you use a cable box, turn it on and set it to the Public Broadcasting Service (PBS) channel in your time zone. If you use a DSS receiver, it must be turned off.

3 Settings are made automatically. When setup is done, this screen appears.

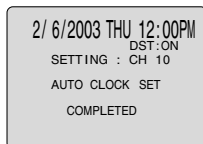

If **AUTO CLOCK SET IS INCOMPLETE** screen appears, set the clock using **MANUAL CLOCK SET** procedure on next page.

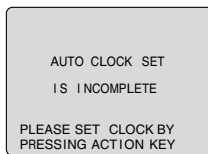

Notes

- Function buttons are inoperative during Initial Setup.
- Depending on conditions, Auto Clock Set may take longer than 30 minutes. If so, press **STOP** to stop setup and perform settings manually. (See page 12-13.)

*Important: If a remote control button does not work when pressed, press the FM/TV button on the remote and try the button again.

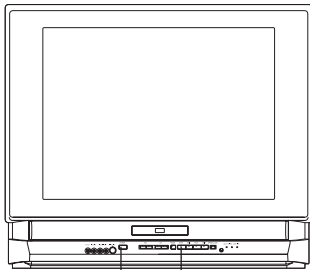
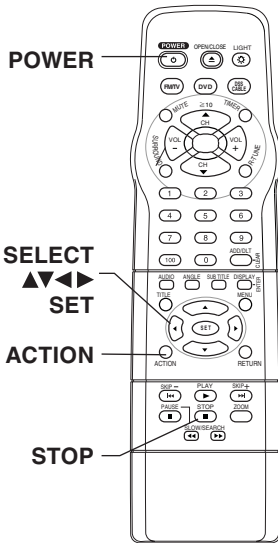

POWER STOP

DST (Daylight Saving Time)

Unit auto adjusts clock for DST (Daylight Saving Time.)

■ Spring (First Sunday in April)

DST: ON → Sets clock ahead one hour.

■ Autumn (Last Sunday in October)

DST: OFF → Turns clock back one hour.

- If your area does not observe Daylight Saving Time, select DST : OFF (see "Clock" on pages 12 and 13).

Note to CABLE system installer:

This reminder is provided to call the CABLE (Cable TV) System Installers attention to Article 820-40 of the NEC that provides guidelines for proper grounding and, in particular, specifies that the cable ground shall be connected to the grounding system of the building, as close to the point of cable entry as practical.

Manual Clock Set

If AUTO CLOCK SET was incomplete, manually set the clock as follows.

1

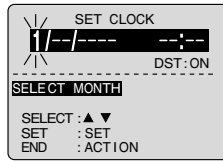

Press **ACTION** on the remote to display SET CLOCK Menu screen.

2

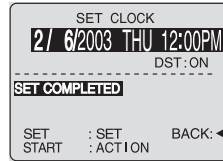

Press **▲▼** to select the month and press **SET** to set. In the same manner, select and set the date, year, time, and DST (Daylight Saving Time).

3

Press **ACTION** twice to start CLOCK and exit.

Reset all unit Memory Functions

When moving unit to a new location, or if a mistake was made in the Initial Setup section.

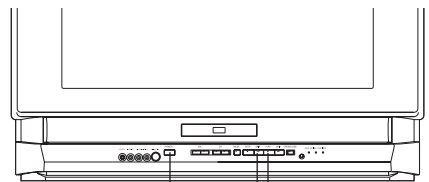

1

Turn the unit Power on.

2

Press and hold both **PLAY** and **◀◀** on the unit for more than 5 seconds.
• The power will shut off.

3

Perform "Initial Setup" on page 10.

Reset Language, Channels, Clock,

1

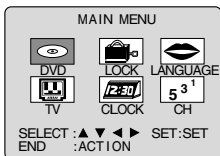

Press **ACTION***
to display MAIN MENU.

2

Language

- 1) Press **▲▼◀▶** to select language icon.

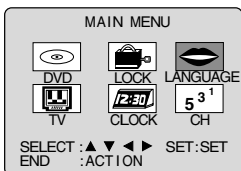

- 2) Press **SET** repeatedly.

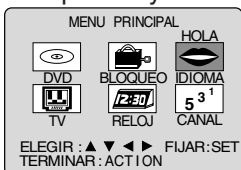

For Spanish

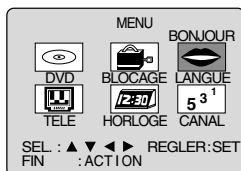

For French

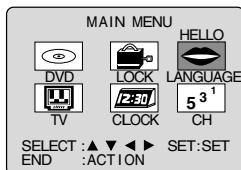

For English

- 3) Press **ACTION** to exit.

Channels

- 1) Press **▲▼◀▶** to select "CH."

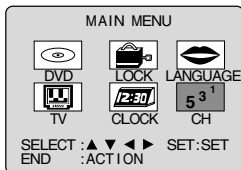

- 2) Press **SET**.

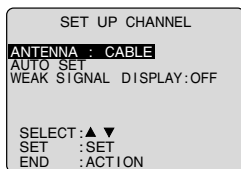

- 3) Press **▲▼** to select "ANTENNA," then press **SET** to set your antenna system ("TV" or "CABLE").

- 4) Press **▲▼** to select "AUTO SET," then press **SET**.

- After Channel Auto Set is finished, Clock Auto Set will be performed. (If clock is set manually, Clock Auto Set will not be performed.)

Clock

- 1) Press **▲▼◀▶** to select "CLOCK."

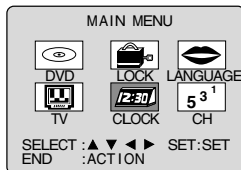

- 2) Press **SET**.

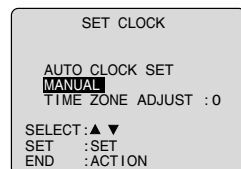

("TIME ZONE ADJUST" appears only when auto clock is set.)

- 3) Press **▲▼** to select "MANUAL," then press **SET**.

(For Auto Clock Set, select "AUTO CLOCK SET," and press **SET**.)



<Example MANUAL CLOCK SET screen>

Continued on
the next page.

Time Zone Adjust

*Important:

If a remote control button does not work when pressed, press the FM/TV button on the remote and try the button again.

- 4) Press **▲▼** and press **SET** to select and set the month, date, year, time, and DST (Daylight Saving Time).

To Make Corrections, repeatedly press **◀▶** to move to error, then correct.

- 5) Press **ACTION** twice to start the clock and exit this mode.

■ Time Zone Adjust

(Only when Auto Clock is set.)

- 1) Press **▲▼◀▶** to select "CLOCK."

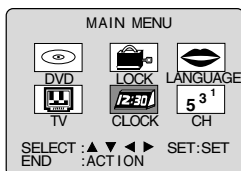

- 2) Press **SET**.

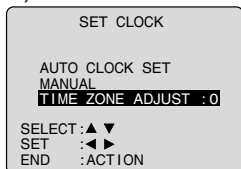

- 3) Press **▲▼** to select "TIME ZONE ADJUST" and press **◀▶** or **▶** to subtract or add hour(s) as necessary.

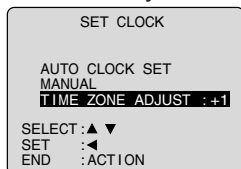

- 4) Press **ACTION** twice to exit.

- "TIME ZONE ADJUST" returns to "0" if clock is set manually.

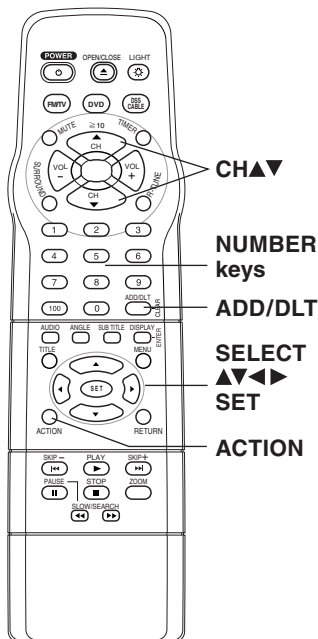

Add or Delete a Channel

To add channel:
Select channel with **NUMBER keys** and press **ADD/DLT**.

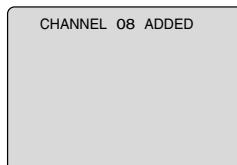

To delete channel:
Select channel with **CH ▲▼** or **NUMBER keys** and press **ADD/DLT**.

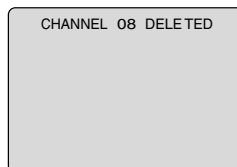

Audio Connections

Enjoy the powerful movie theater and hall-like sound available with multiple channel audio found on DVDs by connecting an amplifier and speakers. There are two types of connection, digital and analog.

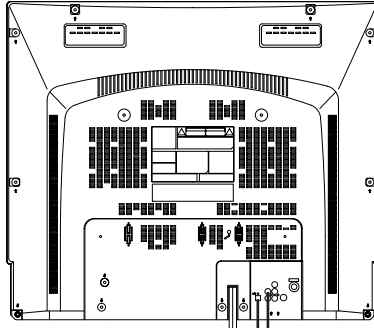

■ Digital connection

Connect an amplifier with Dolby Digital and DTS decoders to enjoy surround sound. You can also enjoy stereo sound with sampling frequencies of 48 kHz if the material is not copy-protected and the equipment you connect is compatible with these signals.

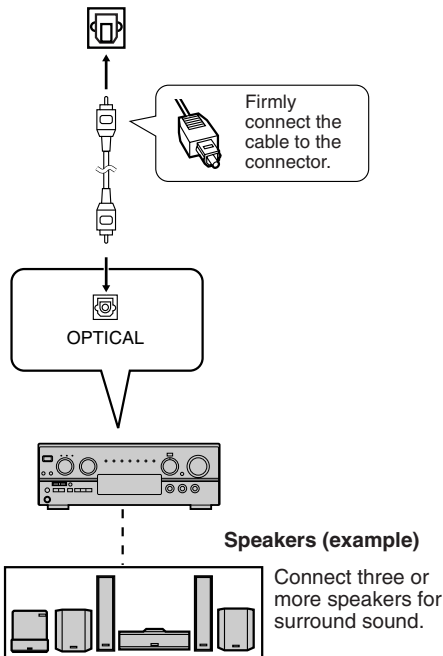

■ Analog connection

Connect an amplifier to enjoy high-quality stereo sound with sampling frequencies of 96 kHz.

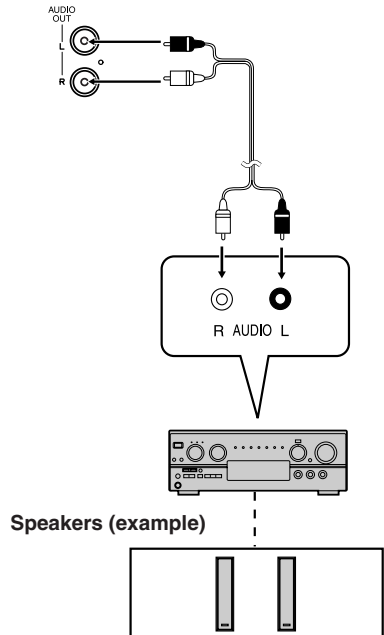

✓ Check List

- Turn down the volume, then turn this unit, as well as other equipment to be connected, off before proceeding with connection.
- Do not block ventilation holes of any equipment and arrange them so that air can circulate freely.
- Read through the instructions before connecting other equipment.
- Ensure that you observe the color coding when connecting audio and video cables.

Enjoying digital audio output from the digital audio output connector

Notes on audio output from the optical digital audio output connector

Disc	Sound recording format	Optical digital audio output from connector
DVD	Dolby Digital	Dolby Digital bitstream (1-5.1 ch) or PCM (48 kHz sampling/16 bit only)* ¹
	Linear PCM (48/96 kHz 16/20/24 bit)	Linear PCM (2ch) (48 kHz sampling/16 bit only)* ²
	dts	Bitstream or PCM (48 kHz sampling/16 bit only)* ¹
Video CD	MPEG 1	PCM (44.1 kHz sampling)
CD	Linear PCM	Linear PCM (44.1 kHz sampling)
MP3	MP3	Linear PCM (It depends on the MP3 file)
WMA	WMA	Linear PCM (It depends on the WMA file)

*¹ The type of audio output from the connector can be selected by the Settings for DVD Operation. (See page 49.)

*² Sound having 96 kHz sampling is converted into 48 kHz sampling when it is output from the unit's optical digital audio output connector.

For your reference:

- Dolby Digital is a digital sound compression technique developed by the Dolby Laboratories Licensing Corporation. Supporting 5.1-channel surround sound, as well as stereo (2-channel) sound, this technique enables a large quantity of sound data to be efficiently recorded on a disc.
- Linear PCM is a signal recording format used in CDs. While CDs are recorded in 44.1 kHz/16 bit, DVDs are recorded in 48 kHz/16 bit up to 96 kHz/24 bit.
- If you have a Dolby Pro Logic Surround decoder, you will obtain the full benefit of Pro Logic from the same DVD movies that provide full 5.1 channel Dolby Digital soundtracks, as well as from titles with the Dolby Surround mark. For information on Panasonic or Technics Dolby Pro Logic Surround Sound Decoders please contact your local dealer.

IMPORTANT NOTE: Caution for optical digital audio output connector:

- When connecting an amplifier (with an Optical digital input connector) which does not contain the Dolby Digital or dts decoder, be sure to select "PCM" at "Dolby Digital" and "PCM" at "dts" of the Settings for DVD Operation "AUDIO OUTPUT" (see page 49). Otherwise, any attempt to play DVDs may cause such a high level of noise that it may be harmful to your ears and damage your speakers.
- When a dts decoder is connected, please select "Bitstream" at "dts" of the Settings for DVD Operation "AUDIO OUTPUT." If "PCM" is selected, there will be stereo sound. (See page 49).
- Video CDs and CDs can be played as usual.

Note

- Some dts decoders which do not support DVD-dts Interface may not work properly with the unit.

Manufactured under license from Digital Theater Systems, Inc. US Pat. No. 5,451,942, 5,956,674, 5,974,380, 5,978,762 and other world-wide patents issued and pending. "DTS" is a registered trademark of Digital Theater Systems, Inc. Copyright 1996, 2000 Digital Theater Systems, Inc. All rights reserved.

Manufactured under license from Dolby Laboratories. "Dolby" and the double-D symbol are trademarks of Dolby Laboratories.

*Important: If a remote control button does not work when pressed, press the DVD button on the remote and try the button again.

■ Forward/Reverse rapid scene search

- Press **SLOW/SEARCH** ►► or **SLOW/SEARCH** ◀◀ during play.
- Press **PLAY** to release.

- Starting forward/reverse search during play started from menu on Video CDs may recall menu.
- Search speed, slow at first, increases with each additional press of the button up to 5 levels.

■ Forward/Reverse Chapter/Track Skip

- Press **SKIP+** ►►| or **SKIP-** |◀◀ during play.

Each **press skips** a chapter (DVD) or track (Video CD/CD).

Pressing SKIP- |◀◀ once midway through a chapter/track returns to start of that chapter/track. Each additional press skips back one chapter/track.

- **Pressing SKIP+** ►►| or **SKIP-** |◀◀ during play started from menu on Video CDs may recall menu.

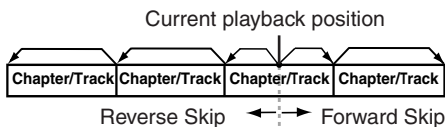

■ Still (Pause) Picture

- Press **PAUSE** during play.
- Press **PLAY** to release.

- **DVD/Video CD** : The unit will enter Still picture mode.
- **CD** : The unit will enter Pause mode.

■ Frame by Frame picture (DVD/Video CD)

- Press **PAUSE** in Still mode.
- Press **PLAY** to release.

- Each press advances picture one frame.
- Hold down for consecutive frame advance.
- Whether pictures are advanced by "FRAME" or "FIELD" is selected automatically (see page 50).

■ Slow Motion picture (DVD/Video CD)

- Press **SLOW/SEARCH** ►► or **SLOW/SEARCH** ◀◀ (DVD only) in Still mode.
- Press **PLAY** to release.

- Slow motion speed, slow at first, is increased with each additional press of the button up to 5 levels.
- Reverse slow motion is not available for video CDs.

- When  appears on the screen while a button is being pressed, it means that the corresponding operation is prohibited by the unit or the disc.

RESUME function

The unit memorizes the point where STOP is pressed.

Press PLAY to resume play from this point.

Pressing STOP again or opening the tray cancels RESUME, however, RESUME is not canceled when power is turned off and on.

- RESUME works only with discs for which elapsed play time is displayed during play.

Auto-Power Off function

Power turns off after unit has been in Stop mode (DVD) for about 5 minutes.

Enjoy Video CDs featuring playback control without using menus (Video CDs only)

1. Do steps 1-3 (previous page).

When menu appears, **press STOP**.

2. **Press NUMBER key(s)** to select desired track (play begins).

- Track disc for track numbers.
- Press "1" to start at beginning of disc.

To Resume Menu use,

Press STOP, and **press PLAY**, then the menu appears. Now, go to step 4 (previous page).

Notes

- Please read the disc jacket for operation information.
- If a single sided disc is placed in upside down, "THIS TYPE OF DISC CANNOT BE PLAYED. PLEASE INSERT A DIFFERENT DISC" is displayed.
- Remove disc and press unit POWER off when not in use.
- Disc continues to rotate with menu displayed even after play is done. Press STOP to clear menu display when finished with menu.

TV Operation

***Important:** If a remote control button does not work when pressed, press the FM/TV button on the remote and try the button again.

1 Press **POWER*** on the remote or unit.

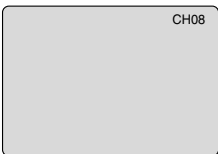
2  Use **CH ▲▼** or **NUMBER** keys to select a channel.

3  Press **VOL +** or **VOL -** to adjust volume.

✓ Check List

- Cable or antenna is connected.
- Power cord is plugged in.

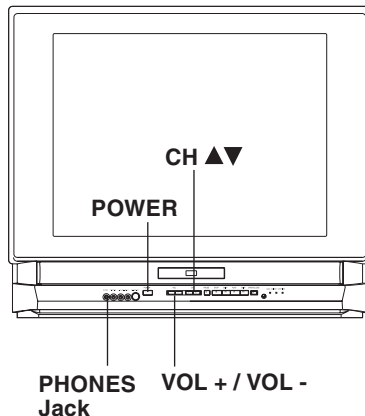

■ Using the 100 key

When selecting CABLE channels 100 to 125 with the NUMBER keys, first press the 100 key, and then enter the remaining two digits.

■ Rapid Tune

Press **R-TUNE** to display the last channel you were watching.

■ Audio Mute

Press **MUTE** to instantly mute the sound. Press again to restore the previous sound level.

■ Phones

Connect an earphone (not supplied) or headphones (not supplied) to the Phones Jack.

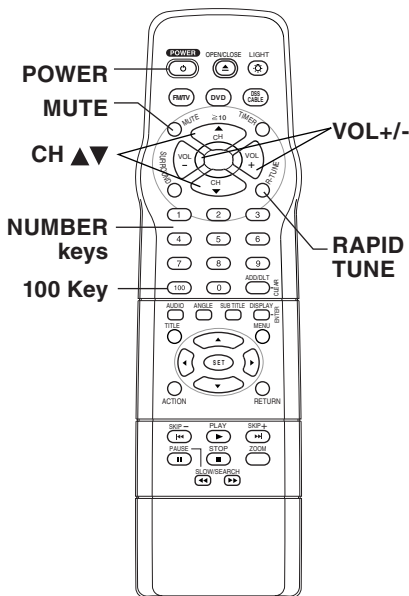

MTS Broadcast/TV Stereo System

Equipped with **dbx**[®]-TV Noise Reduction for true MTS reproduction.
dbx[®]-TV Noise Reduction is required for good stereo separation and audio fidelity.
dbx[®] is a registered trademark, and is licensed by **dbx**[®] Technology Licensing.

Receivable Broadcast Types

The following are possible audio broadcast types and on-screen displays. The signal being received is indicated with an “**Ⓢ**” mark while the selected audio mode is indicated with an arrow. To change the audio mode for these broadcasts, see the “Audio Mode for TV Viewing” section below.

Press DISPLAY to display the broadcast signal being received.

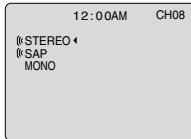
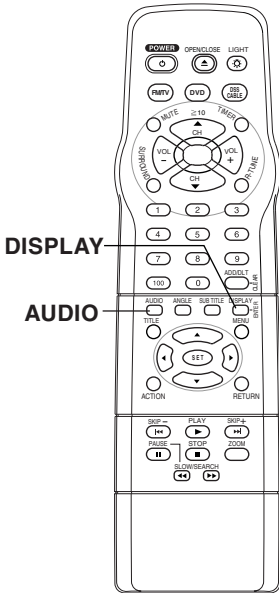

MTS Stereo and SAP broadcast

Multi-channel Television Sound Stereo (main language) and Secondary Audio Program (sub language) broadcasts are being received simultaneously. Select the STEREO or SAP audio mode.

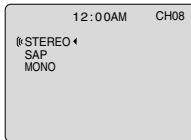

MTS Stereo broadcast

Multi-channel Television Sound Stereo broadcast. Select STEREO audio mode.

- If stereo broadcast is weak and the display flickers, select MONO audio mode for possible improvement.

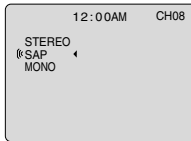

SAP broadcast

Secondary Audio Program (sub language). Select SAP audio mode for the sub language.

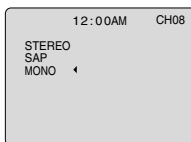

MONO broadcast

Normal monaural sound broadcast.

TV Operation

Audio Mode for TV Viewing

Press AUDIO to select the desired audio mode as described above. (Arrow shows selection.)

- Each press of AUDIO will change the audio mode as shown below.
- “SAP” is selected with first press of AUDIO.

< Example >

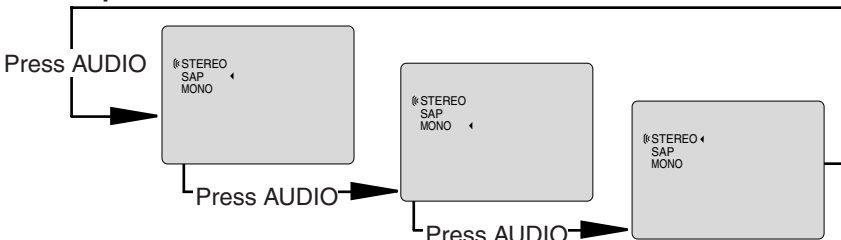

Closed Caption System

Closed Caption is ...

This multi-use system not only allows the hearing impaired to enjoy selected programs, but also makes useful information from TV stations available to everyone.

Closed Caption Mode Feature

1 Press **ACTION*** to display MAIN MENU.

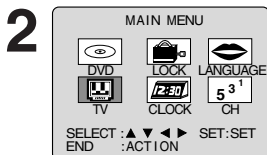

1) Press ▲▼◀▶ to select "TV."

2) Press **SET** to display SET UP TV screen.

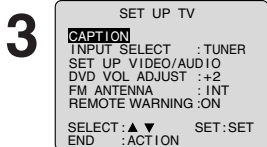

1) Press ▲▼ to select "CAPTION."

2) Press **SET** to display CAPTION screen.

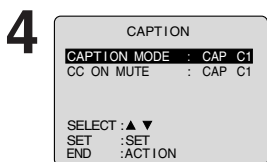

1) Press ▲▼ to select CAPTION MODE.

2) Press **SET** repeatedly to select mode. (See left.)



5 Press **ACTION** three times to return to the normal screen.

Closed Caption Mode Selections

Caption Mode: CAP C1 or C2

A narration of selected TV programs is displayed. Check TV program listings for CC (Closed Caption) broadcasts.

Caption Mode: TEXT C1 or C2

Most of the screen will be blocked out. When the TV station broadcasts information, such as program listings, it will appear in this space.

Caption Mode: OFF

Closed Caption/Text narration will not be displayed.

Note

- The closed caption or text signal may be broadcast over C1, C2, or both. Also, text contents can vary so you may wish to try different settings.

*Important: If a remote control button does not work when pressed, press the FM/TV button on the remote and try the button again.

Caption On Mute Feature

Closed Caption narration, if available, is displayed when MUTE button is pressed.

1 Press ACTION to display MAIN MENU.

2

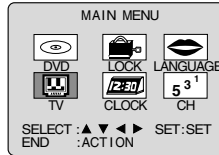

- 1) Press ▲▼◀▶ to select "TV."
- 2) Press SET to display SET UP TV screen.

3

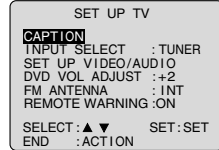

- 1) Press ▲▼ to select "CAPTION."
- 2) Press SET to display CAPTION screen.

4

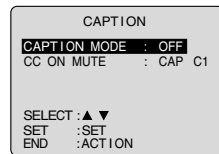

- 1) Press ▲▼ to select CAPTION MODE.
- 2) Press SET repeatedly to select "OFF."

5

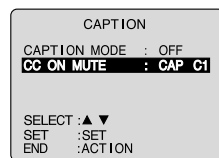

- 1) Press ▲▼ to select CC ON MUTE.
- 2) Press SET repeatedly to select desired mode.
 - Each press of SET will change the display as shown left.
 - The caption may be broadcast over CAP C1 or C2.

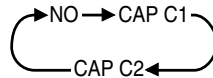

6 Press ACTION three times to return to the normal screen.

7

Press MUTE to mute the sound and display closed captioning.

- To cancel, press MUTE again.

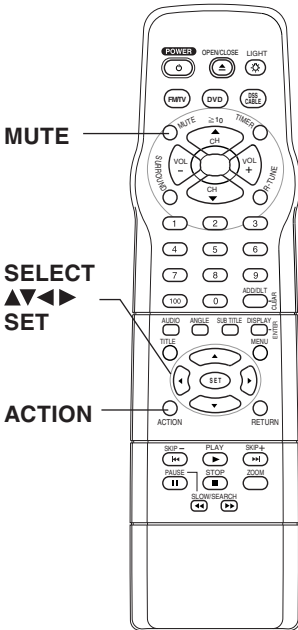

Note

- When a disc supporting closed caption is used, the subtitle and the closed caption may overlap. In this case, turn the subtitle or caption on mute mode off. (See page 36.)

TV Timer Features

ON-TIMER with Alarm

This unit can be set to automatically power on in one of 3 modes (TV, FM radio, or DVD/Video CD/CD.) You can also combine the On-Timer with a one minute alarm that gradually increases in volume.

1 Press **TIMER*** to display SET TIMER screen.

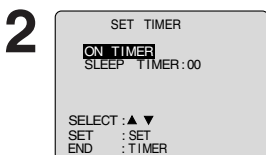

- 1) Press **▲▼** to select "ON TIMER."
- 2) Press **SET** to display ON TIMER screen.

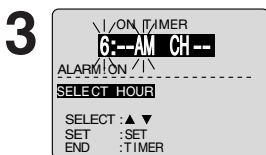

- 1) Press **▲▼** to select desired settings.
- 2) Press **SET** to set the ON-TIMER time or ON-TIMER mode.

- ON-TIMER mode selection order

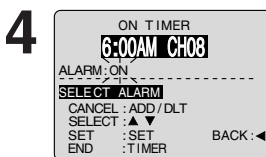
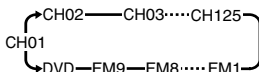

- Press **▲▼** to select ALARM "ON" or "OFF."

When "ON" is selected, an alarm will gradually increase in volume for one minute or until canceled by pressing any button (including VOL + -).

To Make Corrections, use **▲▼** and **◀▶** to move back and correct.

5 Press **TIMER** to set ON TIMER.

- "ON TIMER SET" is displayed.
- ON-TIMER Indicator lights up on the unit.

To Cancel ON-TIMER,

Repeat steps 1 and 2. Then, press **ADD/HLT** to clear the time in step 3. Now, press **TIMER** to end. "ON TIMER END" briefly appears on-screen.

Check List

- The clock is set to the correct time.

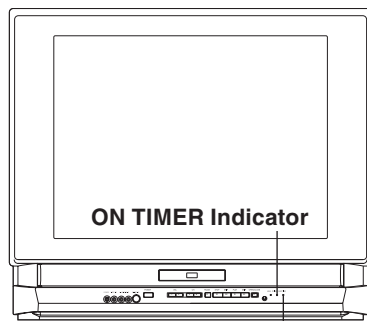

SLEEP TIMER Indicator

Sleep Timer

This unit can be set for auto power off.

1 Press **TIMER** to display SET TIMER screen.

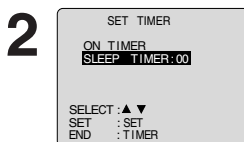

- 1) Press **▲▼** to select SLEEP TIMER.
- 2) Press **SET** repeatedly to select the desired time.

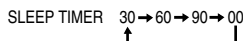

To cancel, press **SET** repeatedly until 00 appears.

3 Press **TIMER** to return to the normal screen.

- Pressing **DISPLAY** with sleep timer set displays remaining time.
- SLEEP TIMER Indicator lights up on the unit.

Note

- If no button on the remote or unit (including a button used to turn off the alarm) is pressed within 60 minutes after unit turns itself on, it will turn itself back off.

On-Screen Display (OSD)

*Important: If a remote control button does not work when pressed, press the FM/TV button on the remote and try the button again.

TV Status & Clock Display

Press **DISPLAY** to display or remove the overlay.

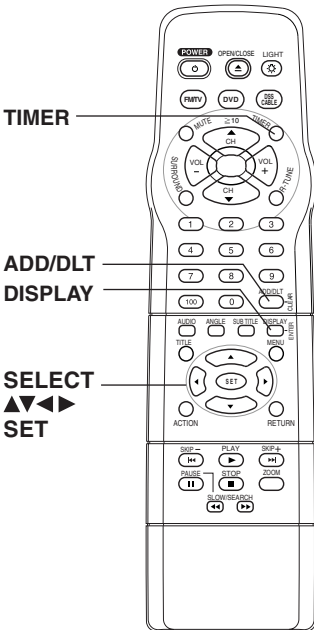
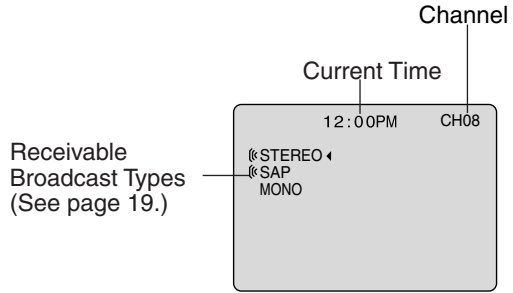

Blue Screen Display

Whenever the selected channel has no broadcast signal with the Weak Signal Display Feature set to "OFF" (see page 28), the screen will turn solid blue.

Channel Display

When you change channels, the channel number will be displayed.

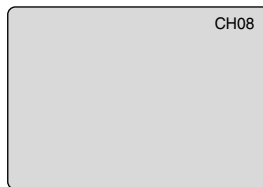

FM Radio

FM Radio is ...

This unit has an FM radio with built-in antenna, 9 station preset, and a band range of 87.5 ~ 108.1 MHz. You can set the On-Timer (page 22) to wake up to your favorite radio station.

FM Radio Setup

- 1 Press **FM/TV*** on the remote to display FM radio mode.

2

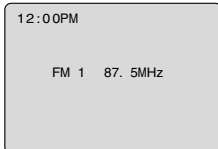

Press a **NUMBER key (1~9)** to select the FM preset number.

3



1) Press **CH ▲▼** to select the desired radio station. (Each press changes frequency by 200 kHz.)

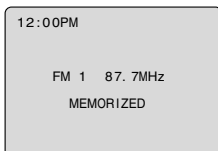

2) Press **ADD/HLT** to set the radio station. **Hold down CH ▲ or ▼** for a few seconds, then release to quickly scan for FM stations in your area.

- To cancel, press **CH ▲** or **▼** while in search mode.

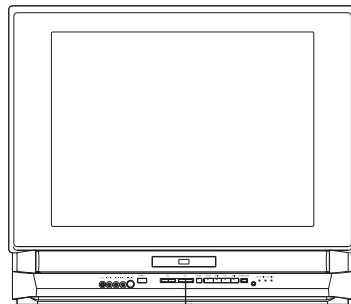

CH ▲▼

To Make Corrections,

select station with a **NUMBER** key, then do step 3 again.

To exit FM mode,

press **FM/TV** or **DVD** on the remote.

FM Antenna Setup

Make sure FM tuning is done correctly (see FM Radio Setup).

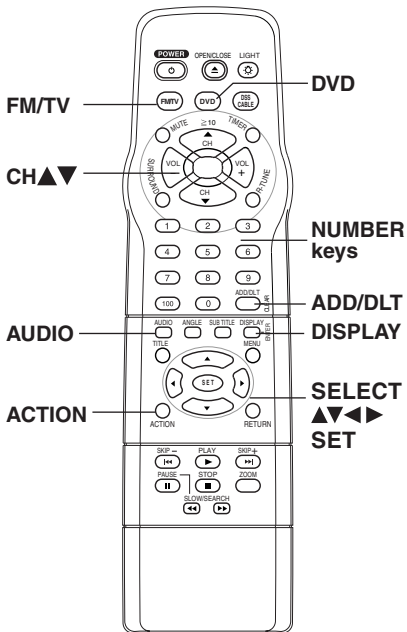

1 Press **ACTION** to display MAIN MENU.

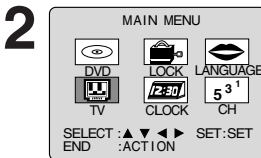

- 1) Press **▲▼◀▶** to select "TV."
- 2) Press **SET** to display SET UP TV screen.

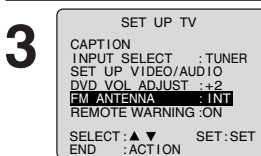

- 1) Press **▲▼** to select **FM ANTENNA**.
- 2) Press **SET** to select "INT (INTERNAL)" or "EXT (EXTERNAL)" to determine which one sounds best.

- For cable TV users → "INT"
- For antenna users → "EXT"

4 Press **ACTION** twice to end setup.

Audio Mode for FM Radio

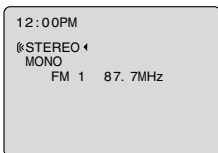

Press **AUDIO** repeatedly to select "STEREO" or "MONO" in FM Radio mode.

Notes

- You may get better reception by repositioning the unit.
- You cannot select FM Radio mode while a blue back screen (ACTION, MENU) is displayed.
- Once stations are set, the selected station and current time are displayed when FM Radio mode is entered. To remove time, press DISPLAY. If DISPLAY is pressed again, the unit status screen appears.

Using FM Radio

1 Press **FM/TV** on the remote to display FM radio mode.

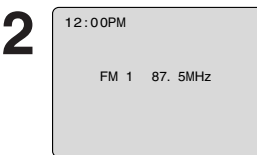

Press a **NUMBER key (1-9)** to select a preset FM number (see FM Radio Setup on page 24).

To exit FM mode, press **FM/TV** or **DVD** on the remote.

Cable Box Universal Remote Control Feature

Universal Remote Control is...

The Remote Control may be set up to control some basic DSS or Cable box functions.

The Universal Remote Control Setup

1 Find your DSS box or Cable box Brand Code Number from one of the charts on the next page.

2 Set up remote. Hold down **DSS CABLE** and press **NUMBER** keys to enter code.

- If code number is 100 or greater, e.g., press 1 - 0 - 2 for 102.

3 Confirm code entry. Press **POWER*** to turn selected unit ON or OFF.

- See below for controllable functions in each mode.

Notes

- Please repeat the Universal Remote Control Setup after replacing remote control batteries.
- The remote control will not operate all DSS receivers or Cable Boxes made by the manufacturers listed. If you get no results, your particular brand cannot be controlled.

Using the Universal Remote Control (Available Buttons / Functions)

Once the remote control has been properly set up, you can select FM/TV, DVD, DSS or CABLE mode depending on which functions you wish to control.

Press FM/TV, DVD or DSS CABLE on the remote control to select the desired mode. (See below for buttons available in each mode.)

Set to FM/TV, DVD:

All TV, FM, and DVD functions.

Set to DSS CABLE:

- CABLE/DSS function, e.g. POWER, ENTER, NUMBER keys (except 100 key), CH UP/DOWN.

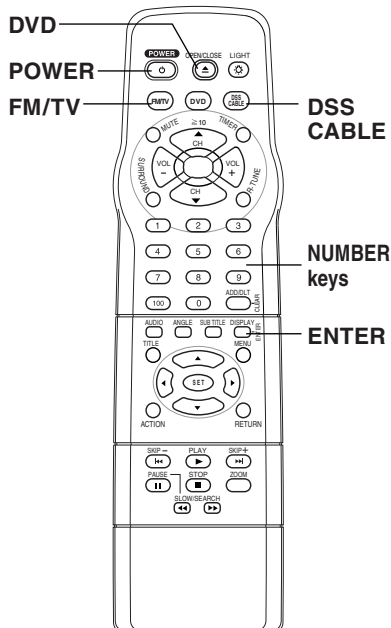

DSS Brand Code Numbers

Toshiba.....	90	Optimus.....	94, 95
Hitachi/ Hughes.....	91, 99	Panasonic.....	96
Primestar.....	92	ProScan.....	97
Drake.....	93	RCA.....	97
Magnavox.....	94, 95	SONY.....	98, 105
Uniden.....	94, 95		

Cable Box Brand Code Numbers

Archer.....	44, 06, 01, 120, 05, 63, 126	Oak Sigma.....	46, 11, 129, 101
Cableview.....	29, 09, 01, 63, 120, 44, 42, 30, 52, 04, 124, 126	Panasonic.....	17, 16, 08, 87, 109
Citizen.....	44, 52, 30, 63, 42, 04, 124, 126	Philips.....	23, 24, 20, 13, 07, 50, 128, 129
Curtis.....	08, 09, 25, 61, 53, 87	Pioneer.....	06, 05, 12
Century.....	44, 51, 75, 59, 126	Pulsar.....	04, 42, 63, 44, 30, 52, 124, 126
Cabletenna.....	29, 09, 01, 63, 120, 44, 126	Quest.....	06, 05, 12
Cable Cinema.....	29, 09, 01, 63, 120, 44, 126	Radio Shack.....	44, 51, 75, 59, 126
Diamond.....	29, 09, 01, 63, 120, 44, 126	RCA.....	17, 16, 08, 87, 109
Eagle.....	62, 40, 22, 13, 58, 20, 26, 107	Realistic.....	44, 51, 75, 59, 126
Eastern.....	28, 29, 130	Recoton.....	44, 51, 75, 59, 126
Explorer.....	08, 09, 25, 61, 53, 87	Regal.....	41, 14, 15, 28, 102, 104, 103, 130
Gemini.....	30, 04, 124	Regency.....	28, 29, 130
General Electric.....	01, 57, 120	Rembrandt.....	44, 42, 63, 29, 01, 32, 39, 120, 126
General Instruments.....	01, 84, 83, 34, 03, 02, 04, 55, 65, 66, 67, 68, 120, 106, 121, 122, 115, 117, 118, 124	Samsung.....	42, 06, 32, 05, 40
Gerrard.....	44, 51, 75, 59	Scientific Atlanta.....	08, 09, 25, 61, 53, 87
GC Electronics.....	44, 42, 63, 29, 30, 52, 04, 124, 126	Sheritech.....	27
Hamlin.....	41, 14, 15, 28, 102, 104, 103, 130	Signal.....	26, 112
Hitachi.....	31	SL Marx.....	42, 06, 32, 40, 43, 44, 52, 63, 126
Jerrold.....	01, 84, 83, 34, 03, 02, 04, 55, 65, 66, 67, 68, 120, 106, 121, 122, 115, 117, 118, 124	Sprucer.....	17, 16, 08, 87, 109
Jasco.....	30, 04, 124	Standard Components.....	32, 39, 42, 44, 126
Macom.....	31	Stargate.....	04, 42, 32, 40, 63, 44, 30, 52, 06, 124, 126
Magnavox.....	26, 112	Sylvania.....	19, 18
Matsushita.....	17, 16, 08, 87, 109	Teknika.....	74, 35
Movietime.....	32, 39, 42, 44, 126, 38, 40	Telecaption.....	77, 127
Maestro.....	74, 35	Televue.....	40, 19, 38, 32, 42, 06
NEC.....	40, 19, 38, 32	Texscan.....	19, 18
NSC.....	40, 19, 38, 32	Tocom.....	34, 33, 01, 42, 66, 120
Novavision.....	08, 09, 25, 61, 53, 87	Toshiba.....	36
Next Level.....	01, 84, 83, 34, 03, 02, 04, 55, 65, 66, 67, 68, 120, 106, 121, 122	Unika.....	44, 42, 63, 29, 01, 126, 120
Oak.....	46, 11, 129, 101	Universal.....	52, 43, 44, 63, 42, 126
		Viewstar.....	62, 40, 22, 13, 58, 20, 26, 107
		Videoway.....	07, 23, 50, 129
		Vidtek.....	64
		Zenith.....	07, 23, 50, 129

Notes

- In DSS or CABLE mode, it may be necessary to press ENTER after pressing NUMBER keys for channel selection.
- In DSS or CABLE mode, POWER, CH Up/Down, NUMBER Keys, ACTION, TIMER, DISPLAY/ENTER, SLOW/SEARCH ►/◀, SKIP+ ►/◀/SKIP- I◀◀, R-TUNE, SELECT, SET, ZOOM, ANGLE, AUDIO, TITLE, SUB TITLE, MENU, or ADD/HLT/CLEAR are not available. Press FM/TV, DVD to use these functions.
- Depending on your DSS receiver or Cable box brand, some of the functions listed may not be remote controllable.
- Some DSS receiver or Cable box brands require you to turn on the power manually.
- Due to changes in infra-red commands used by manufacturers, some brands have several codes. If your unit does not respond to the first code, please try the next one.

Special Features

Remote Warning Feature

When Universal Remote Control (page 26) is used, and this feature is set to "ON," a warning appears whenever an invalid key is pressed in DSS or Cable mode.

1 Press **ACTION*** to display MAIN MENU.

2

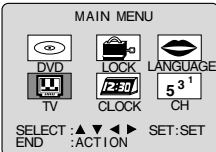

1) Press **▲▼◀▶** to select "TV."
2) Press **SET** to display SETUP TV screen.

3

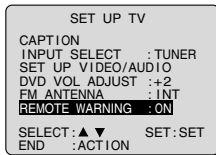

1) Press **▲▼** to select REMOTE WARNING.
2) Press **SET** to set "ON" or "OFF."

- "REMOTE WARNING : OFF"
→ Remote warning will not appear even if invalid key is pressed.

4 Press **ACTION** twice to return to the normal screen.

Weak Signal Display Feature

When "ON" is selected, the picture is displayed even when a broadcast signal is weak or non-existent.

1 Press **ACTION** to display MAIN MENU.

2

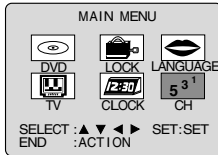

1) Press **▲▼◀▶** to select "CH."
2) Press **SET** to display SETUP CHANNEL screen.

3

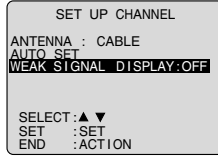

1) Press **▲▼** to select WEAK SIGNAL DISPLAY.
2) Press **SET** to set "ON" or "OFF."

Notes

- "ON" = Picture is displayed regardless of signal condition, and may not always be clearly visible.
"OFF" = Screen turns solid blue when signal is absent or weak.
- If unit is connected to equipment which has blue back feature, selecting "ON" will have no effect on the other equipment.

Selecting Input Mode

Method 1:

Press **CH ▲▼**. The display will change as follows.

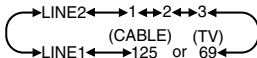

Method 2:

- Press **ACTION** for MAIN MENU.
- Press **▲▼◀▶** to select "TV," then press **SET** for SET UP TV screen.
- Press **▲▼** to select "INPUT SELECT," and then press **SET** to select "TUNER," "LINE1" or "LINE2."
- Press **ACTION** twice to exit this mode.

4 Press **ACTION** twice to return to the normal screen.

Auto Operation Functions

Auto Shut Off

No broadcast signal in TV mode (Only when Weak Signal Display is set to OFF.), DVD stops for 5 minutes.

→ Power turns off

- This feature is canceled if any button is pressed during above conditions.

*Important: If a remote control button does not work when pressed, press the FM/TV button on the remote and try the button again.

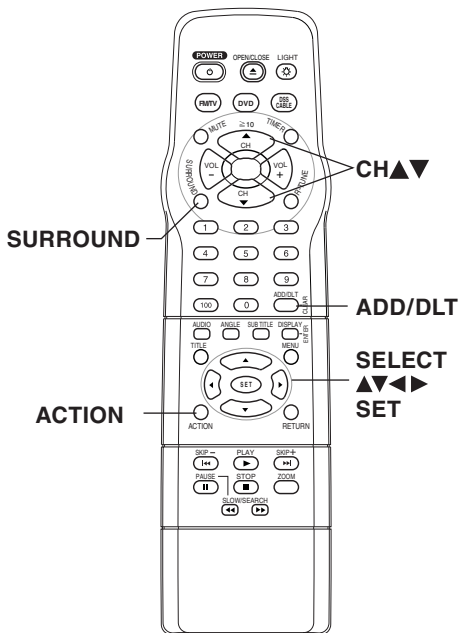

V.S.S. (Virtual Surround Sound) [DVD only]

Enjoy a surround-like effect if you are using two front speakers only. The effect is broadened and sound seems to come from virtual speakers on either side if the disc has surround signals recorded on it.

Press SURROUND in DVD mode.

- The Surround sound effects can be changed by pressing SURROUND repeatedly as shown by the figure below.

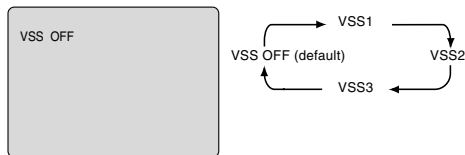

Notes

- V.S.S. effects is available in DVD mode only.
- Turn off the surround effects on the other equipment.
- V.S.S. will not work, or will have less effect, with some discs.
- Turn V.S.S. off if it causes distortion.

DVD Volume Adjust

Some DVDs are recorded in lower average volume level. For these DVDs, this unit can be set so that the average volume is increased automatically.

1 Press ACTION to display MAIN MENU.

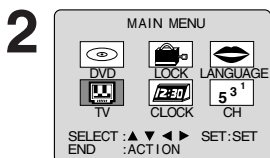

- Press ▲▼◀▶ to select "TV."
- Press SET to display SET UP TV screen.

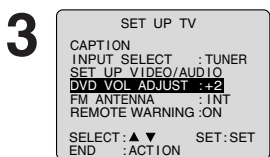

- Press ▲▼ to select DVD VOL ADJUST.
- Press SET to set the level (0, +1, or +2).

4 Press ACTION twice to return to the normal screen.

Surround Sound System

You can hear a deeper, 3-D sound effect using just the unit's two front speakers.

Press SURROUND.

- "SURROUND ON" is displayed.

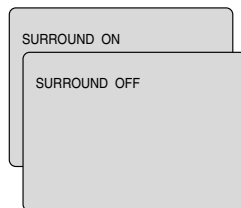

To Cancel, press SURROUND.

Notes

- Surround sound effect is not available for normal (mono) broadcasts.
- The surround effect (TV mode only) is not output to Audio Output L/R Connector.

V-Chip Control Feature

V-Chip Control Feature is...

This unit has a built-in V-Chip Control which allows you to block unwanted TV usage based on US MOVIES and US TV PROGRAMS Ratings.

Process of V-Chip Control Feature

Enter Code → **Setup** → **Blocking**

Enter Secret Code

A 4-digit code must be entered to view a blocked program or change rating settings.

1 Press **ACTION*** to display MAIN MENU.

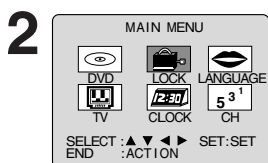

1) Press **▲▼◀▶** to select "LOCK."
2) Press **SET** to display LOCK screen.



1) Press **NUMBER** keys to enter your secret code.
2) Enter same code again for confirmation.

- Step 2) not necessary when changing rating or secret code.
- Take care that you are not observed entering the secret code.

To Make Corrections

Press **◀** repeatedly to move the cursor.

Press **NUMBER** keys to make the correction.

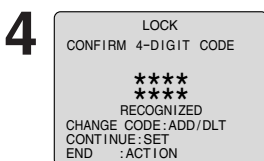

Press **SET** to display US Ratings menu (see pages 31, 32).
Or
Press **ACTION** twice to exit.

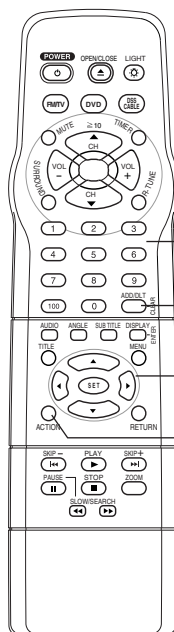

NUMBER key

CLEAR

SELECT
SET

ACTION

Changing your secret code

- You will need your current code.

Do steps 1 ~ 3. In step 4, **press CLEAR** to clear current code.

Repeat steps 3 and 4 to enter new code.

Notes

- DO NOT forget your secret code.
- Once ratings are set, restricted programs cannot be accessed unless the secret code is entered.

*Important: If a remote control button does not work when pressed, press the FM/TV button on the remote and try the button again.

If LOCK menu is not displayed, perform “Enter Secret Code” steps on page 30.

Process of V-Chip Control Feature

Enter Code ⇨ Setup ⇨ Blocking

US MOVIES Ratings

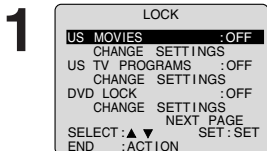

- 1) Press ▲▼ to select US MOVIES.
- 2) Press SET to set “ON” or “OFF.”

- “ON” → V-Chip Control is activated.
- “OFF” → V-Chip Control is deactivated.

Note

- “NEXT PAGE” displays CANADIAN V-Chip setting menu. Not necessary except when viewing Canadian discs or broadcasts.

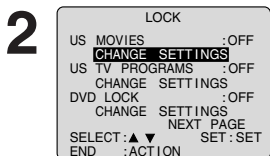

- 1) Press ▲▼ to select CHANGE SETTINGS.
- 2) Press SET to display screen.

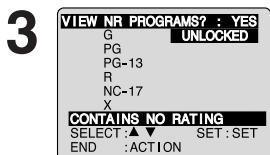

- 1) Press ▲▼ to select VIEW NR PROGRAMS?.
- 2) Press SET to set “YES” or “NO.”

NR (Not Rated) PROGRAMS

Some movies, such as old movies or foreign movies usually have no ratings.

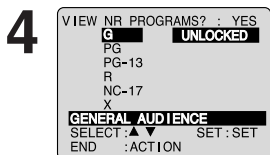

- Press ▲▼ to select and SET to set ratings to be blocked. (See ratings chart on this page.)

- 5 Press ACTION to redisplay LOCK menu and continue with US TV PROGRAMS Ratings (page 32). Or, press ACTION three times to exit.

US MOVIES RATINGS

G	GENERAL AUDIENCE: All ages admitted.
PG	PARENTAL GUIDANCE: Some material may not be suitable for children.
PG-13	PARENTS CAUTIONED: Some material may be inappropriate for children under 13.
R	RESTRICTED: Children under 17 must be accompanied by a parent or adult.
NC-17	OVER AGE 17 ONLY: No one 17 and under admitted.
X	ADULTS ONLY:

V-Chip Control Feature (continued)

If LOCK menu is not displayed, do “Enter Secret Code” steps on page 30.

Process of V-Chip Control Feature

Enter Code ⇨ Setup ⇨ Blocking

US TV PROGRAMS Ratings

1

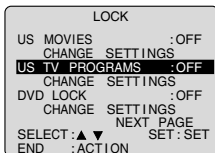

- 1) Press ▲▼* to select US TV PROGRAMS.
- 2) Press SET to set “ON” or “OFF.”

- “ON” → V-Chip Control is activated.
- “OFF” → V-Chip Control is deactivated.

Note

- “NEXT PAGE” displays CANADIAN V-Chip setting menu. Not necessary except when viewing Canadian discs or broadcasts.

2

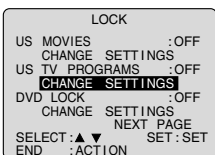

- 1) Press ▲▼ to select CHANGE SETTINGS.
- 2) Press SET to display screen.

3

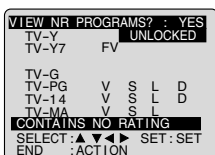

- 1) Press ▲▼ to select VIEW NR PROGRAMS?.
- 2) Press SET to set “YES” or “NO.”

NR (Not Rated) PROGRAMS

Some TV shows, such as news, sports, weather, bulletins, emergency information usually have no ratings.

4

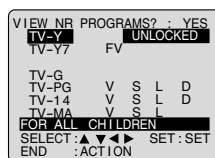

Press ▲▼ to select and SET to set ratings to be blocked. (See ratings charts on this page.)

- Ratings highlighted in green will be blocked. Ratings in white letters will not be blocked.

Note

- You may select from standard TV ratings (chart 1), or customize to a specific content rating (chart 2).

5

Press ACTION three times to exit this mode.

US TV PROGRAMS RATINGS: Chart 1

TV-Y	FOR ALL CHILDREN: Content specifically geared to young viewers ages 2-6.
TV-Y7	FOR AGE 7 AND OLDER: May contain mild physical or comedic violence which may frighten children under 7.
TV-G	GENERAL AUDIENCE: Contains little or no violence, strong language, or sexual dialogue or situations.
TV-PG	PARENTAL GUIDANCE: May contain infrequent coarse language, limited violence, some suggestive sexual dialogue and situations.
TV-14	PARENTS CAUTIONED: May contain sophisticated themes, sexual situations, strong language, and more intense violence.
TV-MA	MATURE AUDIENCE: May contain mature themes, profane language, graphic violence, and sexual situations.

US TV PROGRAMS RATINGS: Chart 2

FV	Fantasy Violence
V	Violence
S	Sexual Situations
L	Adult Language
D	Sexually Suggestive Dialogue

*Important: If a remote control button does not work when pressed, press the FM/TV button on the remote and try the button again.

Process of V-Chip Control Feature

Enter Code → **Setup** → **Blocking**

Blocking Message

<When V-Chip Control is activated>

```

CH08
PROGRAM RATING EXCEEDED
RATING : PG-13
ACCESS CODE  : ----
ENTER  : 0-9
    
```

- If a program or movie exceeds the ratings you have set, a message will appear on a black background and sound is muted.

To View a Blocked Program/Movie [Temporarily Deactivate V-Chip Control]

Enter your secret code (ACCESS CODE) in the Blocking Message screen.

- V-Chip Control is reactivated when power is turned off or power failure occurs.

[Deactivate V-Chip Control]

Enter your secret code (steps 1-3 page 30). Then, set US MOVIES and/or US TV PROGRAMS to "OFF" using ▲▼ and SET. (Ratings set on pages 31 and 32 is retained and will be in effect when V-Chip Control is activated again.)

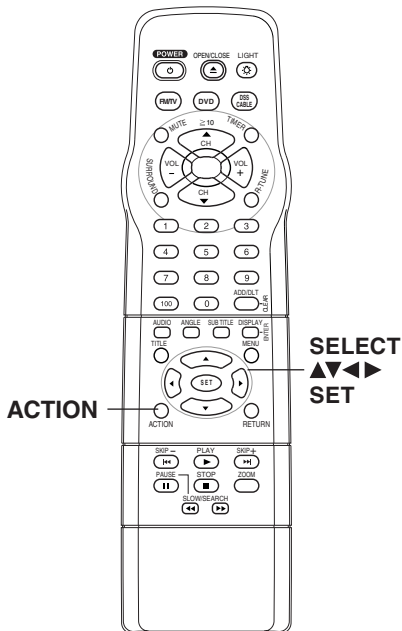

Video/Audio Menu

This feature allows easy setting of picture and sound suitable for each program source.

Video Menu

1 Press **ACTION*** to display MAIN MENU.

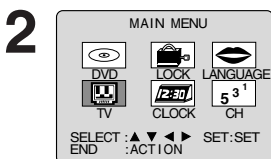

1) Press **▲▼◀▶** to select "TV."
2) Press **SET** to display SET UP TV screen.

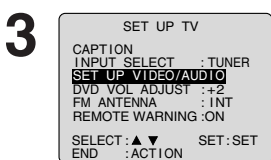

1) Press **▲▼** to select "SET UP VIDEO/AUDIO."
2) Press **SET** to display.

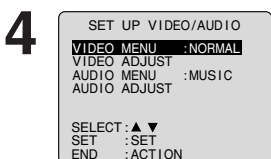

1) Press **▲▼** to select "VIDEO MENU."
2) Press **SET** repeatedly to select desired mode. (See below.)

5 Press **ACTION** three times to end setup.

[Video Menu]

- **NORMAL**
Factory setting.
- **MOVIE**
Picture is adjusted for a movie-like feel.
- **NIGHT**
Color and picture intensity are adjusted to be easier on the eyes for night viewing.

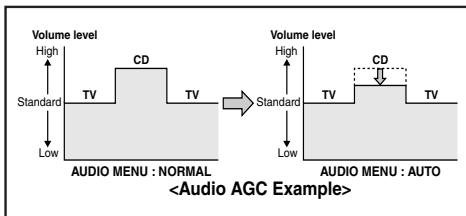

Audio Menu

a Do steps 1 - 3 left.

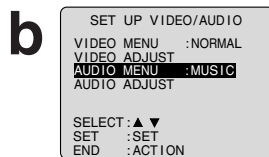

1) Press **▲▼** to select "AUDIO MENU."
2) Press **SET** to select desired mode. (See below.)

c Press **ACTION** three times to end setup.

[Audio Menu]

- **NORMAL**
- **AUTO**
[Audio AGC (Auto Gain Control)]
The sound level is automatically adjusted to suit the program source (see below left).
- **MOVIE**
Sound suited to movies.
- **MUSIC**
Sound suited to music. (Factory setting)
- **SPEECH**
Sound suited to dialogue.

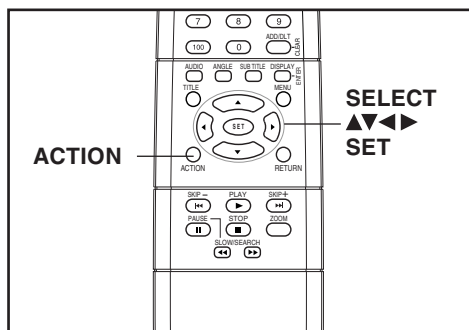

Notes

- The effects of this feature on the signal is not output to the Audio/Video Output Connector.
- When AUDIO MENU mode is "AUTO," the AUDIO ADJUST setting will be "STANDARD."
- AUDIO MENU settings remain in memory.
- VIDEO MENU settings do not remain in memory.

Video/Audio Adjustment

***Important:** If a remote control button does not work when pressed, press the FM/TV button on the remote and try the button again.

Video Adjustment

1 Press **ACTION** to display MAIN MENU.

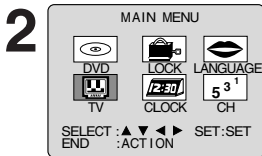

- 1) Press **▲▼◀▶** to select "TV."
- 2) Press **SET** to display SET UP TV screen.

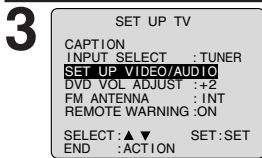

- 1) Press **▲▼** to select "SET UP VIDEO/AUDIO."
- 2) Press **SET** to display.

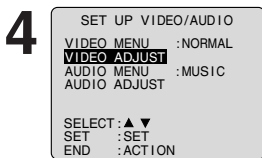

- 1) Press **▲▼** to select "VIDEO ADJUST."
- 2) Press **SET** to display.



- 1) Press **▲▼** to select an item. (See below.)
- 2) Press **◀▶** to adjust.

To Reset VIDEO Controls,

press **▲▼** and **SET** to select and set "STANDARD." All controls return to their factory settings.

6 Press **ACTION** four times to end setup.

[VIDEO Adjustment]

- **COLOR Control**
Adjust color intensity.
- **TINT Control**
Adjust for natural flesh tones.
- **BRIGHTNESS Control**
Adjust picture brightness.
- **PICTURE Control**
Adjust picture intensity by adjusting both contrast and color level in the proper balance.
- **SHARPNESS Control**
Adjust picture sharpness.

Audio Adjustment

a Press **ACTION** to display MAIN MENU.

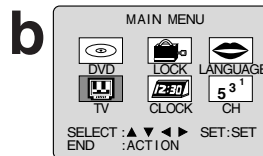

- 1) Press **▲▼◀▶** to select "TV."
- 2) Press **SET** to display SET UP TV screen.

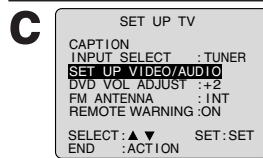

- 1) Press **▲▼** to select "SET UP VIDEO/AUDIO."
- 2) Press **SET** to display.

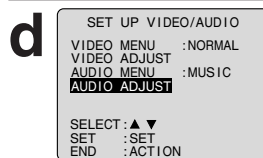

- 1) Press **▲▼** to select "AUDIO ADJUST."
- 2) Press **SET** to display.



- 1) Press **▲▼** to select an item. (See below.)
- 2) Press **◀▶** to adjust.

To Reset AUDIO Controls,

press **▲▼** and **SET** to select and set "STANDARD." All controls return to their factory settings.

f Press **ACTION** four times to end setup.

[AUDIO Adjustment]

- **BASS Control**
To adjust the intensity of low frequency sound.
- **TREBLE Control**
To adjust the intensity of high frequency sound.
- **BALANCE Control**
To adjust the (L/R) unit speaker output level.
 - The levels set here do not affect other audio equipment when connected to the Audio Output L/R Connector.

Disc Operation

Subtitle Language (DVD only)

You can select a different subtitle language (if offered) than the one set at the Settings for DVD Operation. (See page 48.)

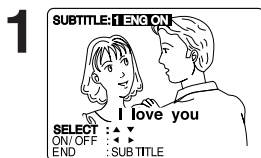

Press **SUB TITLE*** in Play mode to display the subtitle selection on-screen.

- Display disappears after 5 seconds.
- When no subtitles are offered, “-” will be displayed instead of the language number.

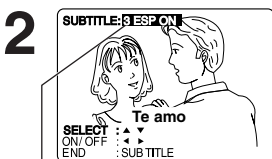

1) Press **▲▼** to select desired language.

2) Press **▶** (or **◀**) to select “ON” or “OFF.”

Number of subtitle language being played back.

Notes

- When closed captioning is used along with subtitles, they may overlap. If so, turn one function off. (See pages 20 and 21.)
- If after several presses of the button the language does not change, language selection is not offered on the disc.
- Subtitles may not change to the selected language immediately.
- When disc is removed, subtitles revert to initial setting language. If the initial language is not recorded on the disc, the disc’s priority language will appear.

Audio Soundtrack Language (DVD only)

You can change the audio soundtrack language, selected at the Settings for DVD Operation, to a different language if available. (See page 48.) (This operation works only with discs on which multiple audio soundtrack languages are recorded.)



Press **AUDIO** in Play mode to display the audio selection on-screen.

- Display disappears after 5 seconds.

Audio attribute 1 type, sampling frequency, bit No. of the disc.



Press **▲▼** to select desired language.

Audio soundtrack language being played back.

✓ Check List

- Please read “Basic DVD Operation” on page 16.

[Subtitle language] [Audio soundtrack language]

ENG	English
FRA	French
DEU	German
ITA	Italian
ESP	Spanish
NLD	Dutch
SVE	Swedish
NOR	Norwegian
DAN	Danish
POR	Portuguese
RUS	Russian
JPN	Japanese
CHI	Chinese
KOR	Korean
MAL	Malay
VIE	Vietnamese
THA	Thai
*	Other

- Change the No. by **pressing ▲▼**, and **press SET**.

[Audio attribute 1 type, sampling frequency, bit No. of the disc (see page 49)]

LPCM	96 kHz	16 bit	Linear PCM disc
	or	20 bit	
	48 kHz	24 bit	
Dolby Digital	1 ch - 5.1 ch	Dolby Digital disc	
dts	1 ch - 5.1 ch	dts disc	

Notes

- If, after several presses of the AUDIO button the language does not change, language selection is not offered on the disc.
- When disc is removed, language reverts to initial setting. If this language is not recorded on the disc, the language recorded will be heard.

*Important: If a remote control button does not work when pressed, press the DVD button on the remote and try the button again.

When  appears on the screen while a button is being pressed, it means that the corresponding operation is prohibited by the unit or the disc.

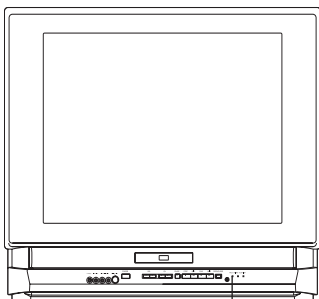

ANGLE Indicator

Notes

- ANGLE Indicator lights up on the unit when a scene recorded at different angles is detected.
- The angle number can be set beforehand so that the angle is switched whenever ANGLE Indicator lights up.

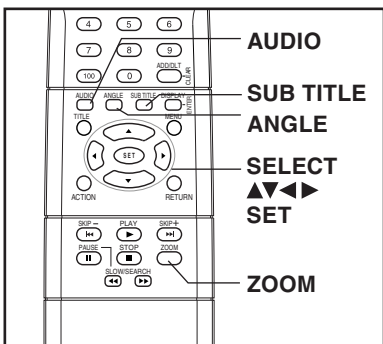

Notes

- Closed captioning will not be displayed while Picture Zoom is used. To see subtitles, set the subtitle feature to ON (see page 36).
- The subtitle cannot be enlarged nor can its position be changed.
- The picture zoom feature does not work with a Video CD.
- During picture zoom, "ZOOM1" or "ZOOM2" appears on-screen for 5 second.
- Zooming, on some discs, may result in poor picture quality, or may not operate at all.

Multiple Angle Viewing (DVD only)

DVDs may contain scenes shot from multiple camera angles allowing the same scene to be viewed at different angles. You can view these angles, if available, using the ANGLE button.

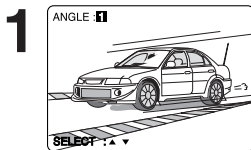

Press ANGLE in Play mode to display the angle selection on-screen.

- Display disappears after 5 seconds.

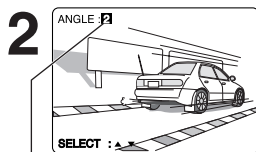

Press ▲▼ to select the desired angle.

Number of angle being played back.

Vocal selection for Karaoke discs (DVD/Video CD)

a **Press AUDIO** in Play mode to display the audio screen.

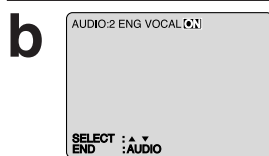

- 1) **Press ▲▼** (or **◀▶**) to select as shown below.
- 2) **Press ▶** (or **◀**) to set. (DVD only)

- DVD Karaoke (1 vocal) VOCAL ON → VOCAL OFF
- DVD Karaoke (2 vocals) VOCAL V1 → VOCAL V2 → VOCAL V1 + V2 → VOCAL OFF
- Video CD LR → L → R

Picture Zoom (DVD only)

You can enlarge specific portions of a picture and select the zoom ratio using the ZOOM button on the remote during DVD playback.

Set Zoom size.

Press ZOOM repeatedly to change display as follows.

- You can enlarge the center portion of the image to one of 2 magnifications.

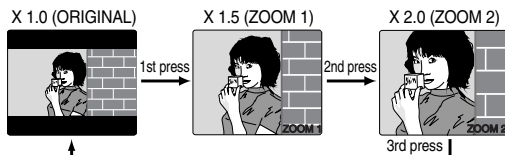

- Use the **▲, ▼, ◀** and **▶** buttons to move the position up, down, left and right.

Advanced Operation

Disc Operation (continued)

Title menu (DVD only)

Some DVDs have more than one title, e.g. movies. If the disc offers a title menu, you can select the desired title number. (Operation may vary according to the disc.)

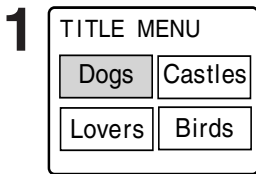

<Example>

Press **TITLE*** in Play mode to display title screen.

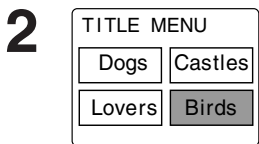

<Example>

- 1) Press **▲▼◀▶** or **NUMBER key(s)** to select a title.
- 2) Press **SET** or **PLAY** to start play.

• Step 2) not necessary when using **NUMBER key(s)**.

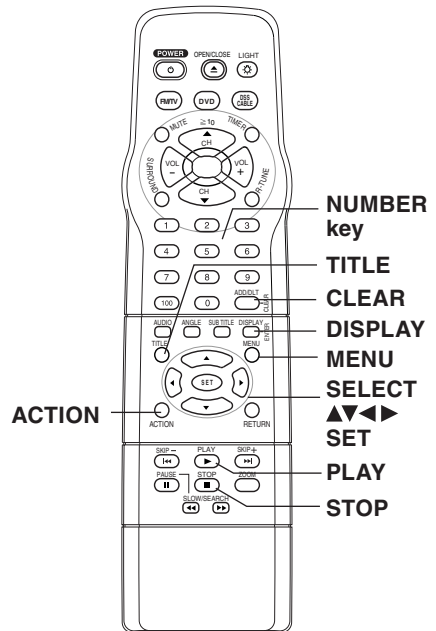

DVD menu (DVD only)

DVDs may offer a special menu. This menu may include guides to unique contents, audio/subtitle languages, etc. Although contents and operation may vary, the following steps show basic steps for using the menu.

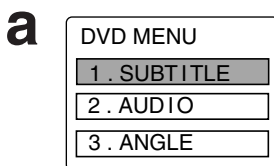

<Example>

Press **MENU** in Play mode to display DVD menu.

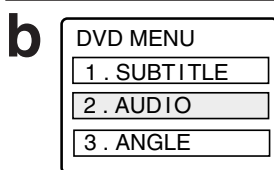

<Example>

- 1) Press **▲▼◀▶** or **NUMBER key(s)** to select an item.
- 2) Press **SET** or **PLAY** to access.

• Step 2) not necessary when using **NUMBER key(s)**.

Repeat step “b” if there is more than one menu.

*Important: If a remote control button does not work when pressed, press the FM/TV, DVD button on the remote and try the button again.

Program Play (Video CD/CD)

You can program specific tracks and order of play.

1 Press **ACTION** in Stop mode to display MAIN MENU.

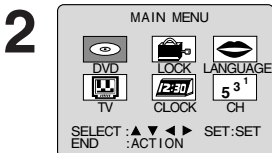

- 1) Press **▲▼◀▶** to select "DVD."
- 2) Press **SET** to display screen.



- 1) Press **▲▼** to select "PLAY MODE."
- 2) Press **SET** to display screen.



- 1) Press **▲▼** to select "PROGRAM PLAY."
- 2) Press **SET** to display screen.

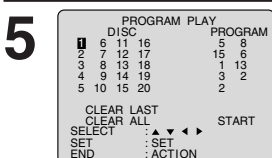

- 1) Press **▲▼◀▶** to select a track number. (Track numbers on disc are displayed.)
- 2) Press **SET** to set.

- Repeat step 5 to select another track.
- The selected track is added on the right side.

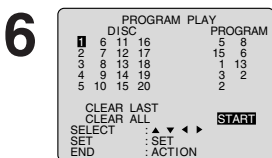

- 1) Press **▲▼◀▶** to select "START."
- 2) Press **SET** to start play of programs in the sequence selected.

- To cancel, press **STOP** during play, then press **CLEAR**.

Notes

- Up to 15 tracks can be programmed.
- "◀" or "▶" (depending on disc) indicates additional PROGRAM PLAY screen. Press **▲▼◀▶** for next or previous screen.
- To clear the last program one by one, Press **▲▼◀▶** to move to "CLEAR LAST" and press **SET**. (Pressing **CLEAR** also clears last program.)
- To clear all programs, Press **▲▼◀▶** to move to "CLEAR ALL" and press **SET**. (Programs are also cleared when the power is turned off or the disc is removed.)

✓ Check List

- Unit is in TV mode, press FM/TV.
- Video CD or CD is inserted.

Program Repeat Play (Video CD/CD)

a Do steps 1 through 6 on this page.

b Press **DISPLAY** to display Disc Information screen.

(Disc Information Screen)

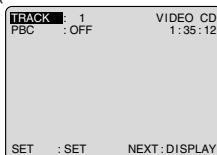

c Press **DISPLAY** again to display Unit Information screen.

d Press **SET** to enter Select mode. Cursor move to "OFF."

(Unit Information Screen)



e Press **▲▼** to select "DISC."

(Unit Information Screen)



f Press **SET** to set mode. Cursor move to "REPEAT." To cancel, select "REPEAT: OFF" in step e, then press **SET**.

Disc Operation (continued)

Random Play (Video CD/CD)

Tracks are played in a random order.

- 1 Press **ACTION*** in Stop mode to display MAIN MENU.

2

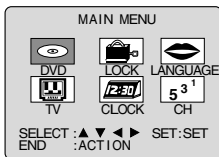

- 1) Press **▲▼◀▶** to select "DVD."
- 2) Press **SET** to display screen.

3

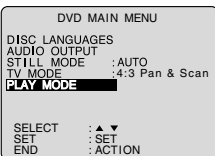

- 1) Press **▲▼** to select "PLAY MODE."
- 2) Press **SET** to display screen.

4

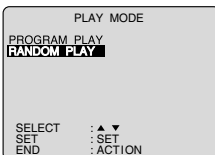

- 1) Press **▲▼** to select "RANDOM PLAY."
- 2) Press **SET** to begin random play.

*Important: If a remote control button does not work when pressed, press the FM/TV button on the remote and try the button again.

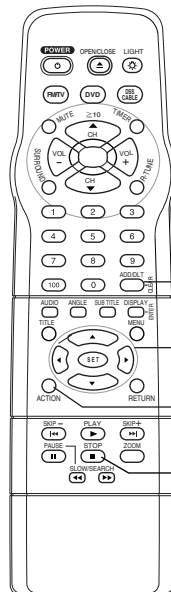

CLEAR

SELECT
▲▼▶

SET

ACTION

STOP

• To cancel, press **STOP** during play, then press **CLEAR**.

DVD Operation using On-Screen Displays

When DISPLAY is pressed, On-Screen Displays show disc information (title/chapter/track number, elapsed playing time) and unit information (Repeat Play, Play mode).

1 Press DISPLAY in Play or Stop mode to display "On-Screen Display."

- Each **press** of DISPLAY changes the on-screen display as follows. (Please refer to page 42 or 43.)

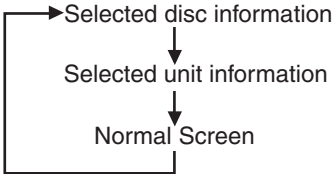

Note

- DISPLAY button does not function while DVD TITLE MENU is displayed.

2 1) Press ▲▼ (or ◀▶) to select an item. 2) Press SET to set.

3 1) Press ▲▼ to select the setting. 2) Press SET to set.

<Example of DVD>

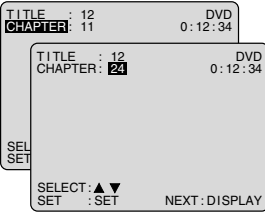

- When numbers are displayed (e.g. title number), the **NUMBER keys** are also available.
- If the number entered is not on the disc, the entry will have no effect. Re-enter the correct number.
- For more details, refer to the disc operation information.

<Example of Video CD>

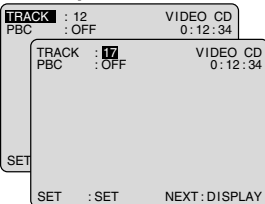

To return to the normal screen, press CLEAR or DISPLAY repeatedly.

✓ Check List

- Unit is in DVD mode, press DVD.

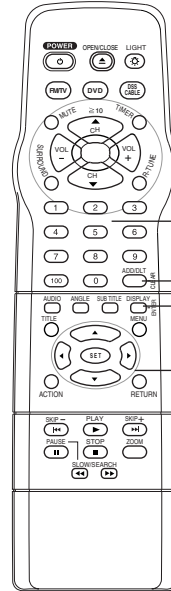

NUMBER keys

CLEAR DISPLAY

**SELECT
▲▼◀▶
SET**

Notes

- When **DISPLAY** is pressed during play of a Video CD with Play control, the **NUMBER keys** are not available on the displayed screen. In this case, **press DISPLAY** again to remove the displayed screen.
- When  appears on the screen while a button is being pressed, it means that the corresponding operation is prohibited by the unit or the disc.

DVD Operation using On-Screen Displays (continued)

Detailed Descriptions of Each On-Screen Display

Disc information screen (for DVD)

1. TITLE No.

- Select "TITLE," and press **SET**.*
- Change the No. by pressing **▲▼** or **NUMBER** keys, and press **SET**.

2. Chapter No.

- Select "CHAPTER," and press **SET**.
- Change the No. by pressing **▲▼** or **NUMBER** keys, and press **SET**.

3. Disc currently being played

4. Elapsed playing time

The screen may be changed by selecting the elapsed time.

- Select the elapsed playing time ("xx:xx:xx"), and press **SET**.
- Change the elapsed time by pressing **NUMBER** keys. Hours → Minutes → Seconds are entered in order. If the time entered is not on the disc, the entry will have no effect. Re-enter the correct time. e.g., press 0 - 1 - 2 - 3 - 4 - 5 for 01 : 23 : 45.

Hour Minutes Seconds

- This function does not work with some discs.

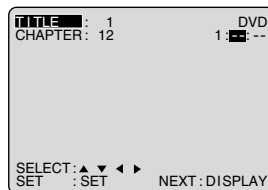
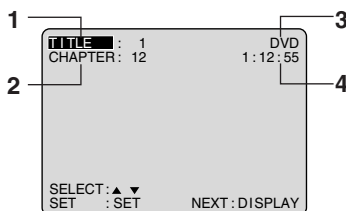

If **SET** is pressed while making entries, unit returns to the condition before entries were made.

Disc information screen (for Video CD/ CD)

A. Track No.

- Select "TRACK," and press **SET**.
- Change the No. by pressing **▲▼** or **NUMBER** keys, and press **SET**.

B. Playback control ON/OFF

[Video CD with playback control only]

ON	Video CD menu play is displayed.
OFF	Video CD menu play is not displayed.

C. Disc currently being played

Video CD	CD
----------	----

D. Elapsed playing time

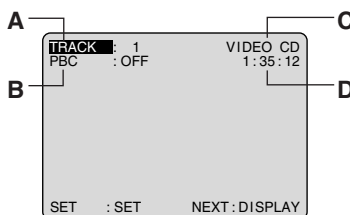

Notes

- Track No. and elapsed playing time are not displayed during play started from menu of Video CDs with playback control.
- When \emptyset appears on the screen while a button is being pressed, it means that the corresponding operation is prohibited by the unit or the disc.

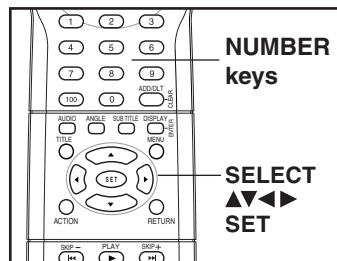

*Important: If a remote control button does not work when pressed, press the DVD button on the remote and try the button again.

Detailed Descriptions of Each On-Screen Display

Unit information screen

- Select “REPEAT,” and press **SET**.
- Change the desired mode during play by pressing **▲▼**, and press **SET**.

a. Repeat Play

DVD	CHAPTER REPEAT	TITLE REPEAT	REPEAT OFF
Video CD/CD	TRACK REPEAT	DISC REPEAT	REPEAT OFF

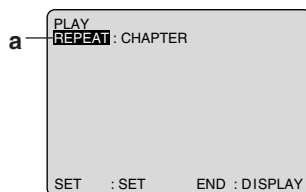

b. Play mode [Video CD/ CD only] (See page 39 or 40.)

PROGRAM PLAY	program play
RANDOM PLAY	random play
----	normal play



For your reference

• CHAPTER/TITLE REPEAT PLAY (DVD)

CURRENT PLAYBACK POSITION

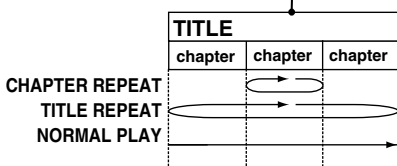

• TRACK/DISC REPEAT PLAY (Video CD/CD)

CURRENT PLAYBACK POSITION

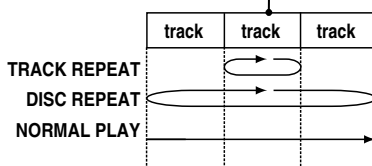

MP3/WMA/JPEG Playback Operation

This unit can play MP3/WMA/JPEG format CD-R or CD-RW recorded for personal use on a PC, etc. Some discs may not play due to recording condition.

1 Press POWER* on the remote or unit.

2 Press OPEN/CLOSE, and then place an MP3/WMA/JPEG disc into the disc tray. **Press OPEN/CLOSE** to close.

3

- MP3/WMA/JPEG menu is displayed.
- Playback starts automatically (except JPEG files).
- CD directory is displayed.

4 Press ◀▶ to move cursor to File area or PLAY MODE. (In STOP mode)

■ File area Operation (In STOP mode)

Press **▲▼** to select items and **SET** or **PLAY** to start.

Press **SKIP+ ▶▶|** (next) or **SKIP- |◀◀** (previous) to skip a file/folder page (7files) in the File area.

Select an MP3/WMA file (🎵/🎵).
MP3/WMA Playback (See next page)

Select an JPEG file (📷).
JPEG Playback (See next page)

Select a folder (📁).
Display files/folders contained in the folder.

Select a Parent folder (📁).
Make changes to the previous directory display.

■ Play mode Operation (In STOP mode)

Press **▲▼** to select the desired **PLAY MODE**.

5 Press ACTION to return to the DVD MAIN MENU. (Press **ACTION** again to return to the MP3/WMA/JPEG MENU.)

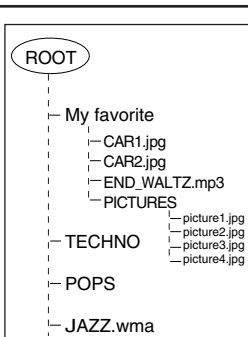

Example: If the CD-R/CD-RW file hierarchy is displayed on the PC as shown in diagram at left, MP3/WMA/JPEG Menu Screen, like the one below is displayed.

Note

- File names are displayed in ascending order (1, 2, 3...9, A, B, C...Y, Z) in the MP3/WMA/JPEG MENU Screen ROOT.

MP3/WMA/JPEG MENU SCREEN

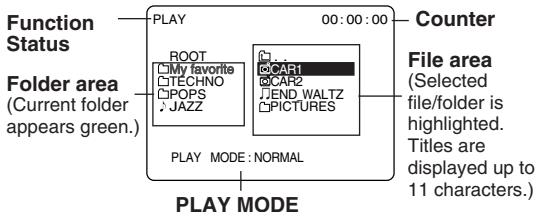

Explanation of Icons



PLAY MODE selection

PLAY MODE:	MP3/WMA Playback	JPEG Playback - Slide-show -
NORMAL	All MP3/WMA files are selected and played back one time only.	All JPEG files are selected and played back one time only.
SINGLE REPEAT	The selected MP3/WMA file is played back repeatedly.	The selected JPEG file is played back repeatedly.
FOLDER REPEAT	The MP3/WMA files contained in the selected folder are played back repeatedly. However, folders below the selected folder are not played back.	The JPEG files contained in the selected folder are played back repeatedly. However, folders below the selected folder are not played back.
DISC REPEAT	All MP3/WMA files are played back repeatedly.	All JPEG files are played back repeatedly.

MPEG Layer-3 audio decoding technology licensed from Fraunhofer IIS and Thomson multimedia.

MP3
PLAYBACK

Windows Media, and the Windows logo are trademarks, or registered trademarks of Microsoft Corporation in the United States and/or other countries. WMA is a compression format developed by Microsoft Corporation. It achieves the same sound quality as MP3 with a file size that is smaller than that of MP3.



MP3/WMA Playback

- Do steps 1~3 on page 44.
Press **▲▼** to select an MP3/WMA file (🎵) in STOP mode.

- Press **SET** or **PLAY** to start playback.

Forward/Reverse Search

Press **SLOW/SEARCH ►►** or **SLOW/SEARCH ◄◄** during play.
Press **PLAY** to release.

- Search speed, slow at first, increases with each additional press of the button up to 5 levels.

Forward/Reverse Track Skip

Press **SKIP+ ►►►** or **SKIP- ◄◄◄** during play.
Each press skips a track.

- If pressed within first 3 seconds of playback, skips to the previous track. If over 3 seconds, returns to top of track. (**SKIP- ◄◄◄** only.)
- Put unit in Stop mode before performing folder/file selection (see step 4 on previous page.)

Pause

Press **PAUSE** during play.
Press **PLAY** to release.

- Press **STOP** to stop play.

- Press **OPEN/CLOSE** to eject the disc.
The MP3 MENU is closed automatically.

Note

- Copyright protected files and files containing errors cannot be played back. The unit skips to the next file.

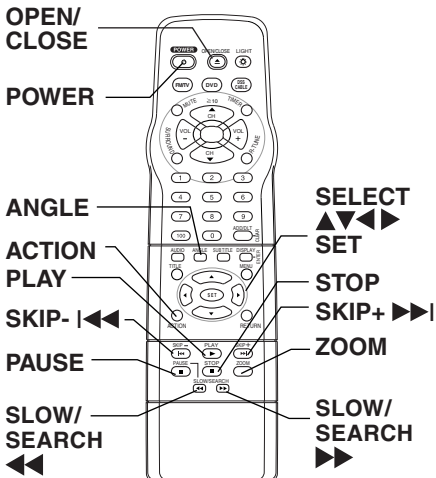

JPEG Playback

You can play JPEG images.

Displayable Image Size: 32x32~7680x7680 pixels

Note

- Some JPEG format may not be played back.

- Do steps 1~3 on page 44.

Press **▲▼** to select an JPEG file (🖼️).

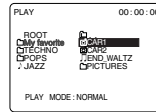

- Press **SET** or **PLAY**. Selected file is displayed.

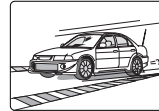

JPEG Playback Screen

<Example: CAR1>

Next/Previous Search

Press **SKIP+ ►►►** or **SKIP- ◄◄◄**

<Example>

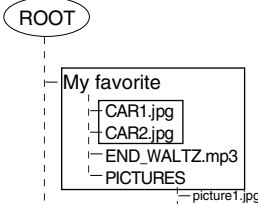

Only the JPEG files in a folder that were saved while being displayed are displayed.

<Example: CAR1>

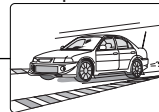

<Example: CAR2>

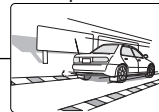

SKIP- ◄◄◄

SKIP+ ►►►

Start Slide-show

Press **SLOW/SEARCH ►►** or **SLOW/SEARCH ◄◄**.
(see next page)

Enlarging an image

Press **ZOOM**. (see next page)

Rotating an image

Press **ANGLE**. (see next page)

Returned on the MP3/WMA/JPEG MENU

Press **STOP**. (see previous page)

- Press **ACTION** to return to the DVD MAIN MENU.

MP3/WMA/JPEG Playback Operation (continued)

JPEG Playback - Zoom -

(During JPEG Playback.)

You can enlarge specific portions of a JPEG picture and select the zoom ratio using the ZOOM button on the remote during JPEG Playback.

Set Zoom size.

Press ZOOM repeatedly to change display as follows.

Press STOP to return to the MP3/WMA/JPEG MENU.

- You can enlarge the center portion of the image to one of 2 magnifications.
- Operation can be done during Rotation (below).

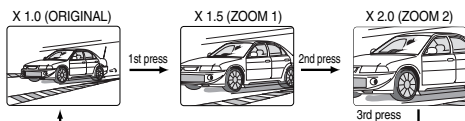

- Use the ▲, ▼, ◀ and ▶ buttons to move the position up, down, left and right.

Note

- Position cannot be changed on X1.0 ORIGINAL images.

JPEG Playback - Rotation -

(During JPEG Playback.)

You can rotate a JPEG picture using the ANGLE button on the remote during JPEG Playback. (The JPEG picture will be rotated 90° clockwise.)

Set rotation.

Press ANGLE repeatedly to change display as below. (During JPEG Playback screen)

Press STOP to return to the MP3/WMA/JPEG MENU.

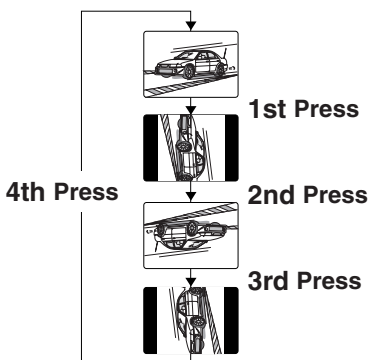

Notes

- Operation can be done during ZOOM (above).
- The vertical/horizontal ratio of rotated JPEG images may vary when they are displayed.

JPEG Playback - Slide-show -

(During JPEG Playback.)

JPEG files are displayed automatically (about every 3 seconds) as a slide-show.

- 1 Press SLOW/SEARCH ►► or SLOW/SEARCH ◀◀.

Only the JPEG files in a folder that were saved while being displayed are displayed.

<Example>

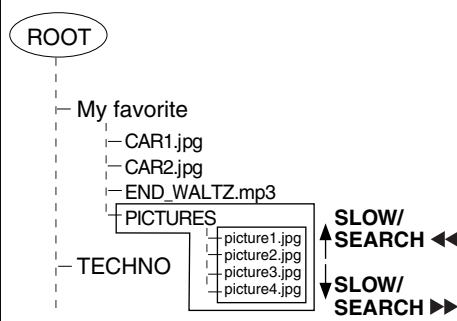

<Example>

If SLOW/SEARCH ►► is pressed while picture 1 is displayed.

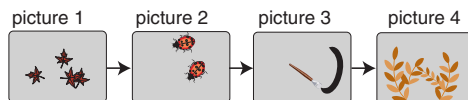

Image changes every 3 seconds.

If SLOW/SEARCH ◀◀ is pressed while picture 3 is displayed.

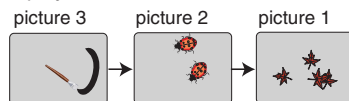

Image changes every 3 seconds.

- **Still picture**
Press PAUSE (only SLIDE)
- **Forward/Reverse Track Skip**
Press SKIP+ ►►| or SKIP- |◀◀. Each press skips a file.
- **Cancel slide show**
Press STOP to return to the MP3/WMA/JPEG MENU.

- 2 Press ACTION to return to the DVD MAIN MENU.

DVD Lock Feature

*Important:
If a remote control button does not work when pressed, press the FM/TV, DVD button on the remote and try the button again.

You can prevent playback of DVDs with a specific rating level which may be unsuitable for children.

- Some DVDs are encoded with a rating level. If the disc rating is higher (stricter) than the one you preset, playback will be prohibited.

Caution

Discs not encoded with a rating level will play even if the jacket states it is for mature audiences. For these discs, the DVD Lock Ratings will not work.

DVD Lock Ratings (DVD only)

Perform DVD Lock setting in TV mode.
Enter your secret code to display LOCK menu.
(Perform "Enter Secret Code" steps on page 30.)

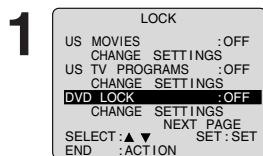

- 1) Press ▲▼ to select "DVD LOCK."
- 2) Press SET to set "ON" or "OFF."

- "ON" → DVD Lock is activated.
- "OFF" → DVD Lock is deactivated.

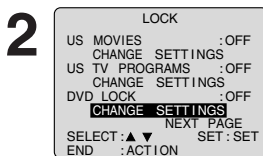

- 1) Press ▲▼ to select "CHANGE SETTINGS."
- 2) Press SET to display screen.

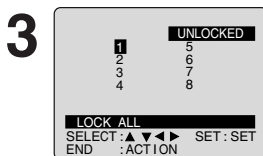

- 1) Press ▲▼◀▶ to select rating level.
- 2) Press SET to select "LOCKED" or "UNLOCKED."

- LEVEL 1:** LOCK ALL:
Playback of all DVDs, CDs and Video CDs is prohibited. (Use to prohibit play of mature theme DVDs not encoded with a rating level.)
- LEVEL 2:** DVDs expressly for children can be played back.
- LEVEL 3 to 7:** DVDs for general audiences/children can be played back. (DVDs with mature content are prohibited.)
- LEVEL 8:** NO LIMIT: (Factory preset)
All DVDs can be played back.

- Ratings which are highlighted in Green will be blocked; those not highlighted (white letters) will not be blocked.

4 Press ACTION three times to exit.

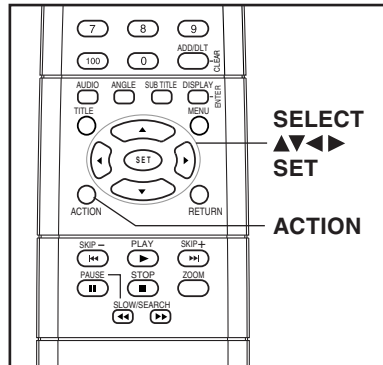

<When DVD Lock is activated>

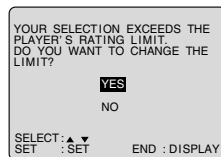

After DVD Lock is set and a blocked DVD is played, this message will appear. The message may differ depending on the disc.

To continue viewing a blocked program for now, Press ▲▼ to select "YES" and SET. Then, enter your 4-digit secret code. When "NO" is selected, blocked programs cannot be viewed.

<When blocked programs>

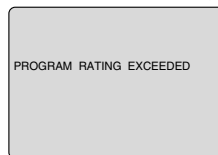

To change DVD LOCK settings

After entering your secret code in step 3 on page 30, select "OFF" to deactivate DVD Lock or change the rating level.

Settings for DVD Operation

- 1** Press **ACTION*** in Stop mode to display MAIN MENU.

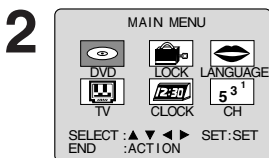

- 1) Press **▲▼◀▶** to select "DVD."
2) Press **SET** to display screen.



- 1) Press **▲▼** to select an item.
2) Press **SET** to set.

DISC LANGUAGES (See below.)

Any languages offered on the disc can be set. If a language not offered is set, the original disc language will be selected.

AUDIO OUTPUT (See page 49.)

You can set the audio output that comes from the digital audio output terminal.

STILL MODE (See page 50.)

To select "FIELD" or "FRAME" to prevent jitter or to make small text or fine patterns clearly visible in a still picture. When "AUTO" is set, "FIELD" or "FRAME" is selected automatically.

TV MODE (See page 50.)

To select whether the video material for a wide-screen will be played back in Pan & Scan style or in Letterbox style.

DISC LANGUAGES (DVD only)

To select and set the language of the audio soundtrack, subtitles, or title/DVD menus for all discs to be played.



- 1) Press **▲▼** to select "DISC LANGUAGES."
2) Press **SET** to display screen.



- 1) Press **▲▼** to select an item.
2) Press **SET** repeatedly for desired language. (Please refer right.)

- 6** Press **ACTION** to redisplay DVD MAIN MENU and go to step 3 to setup another item. Or, press **ACTION** three times to exit.

Once initial settings are done, they remain in memory (even after the power is off) until changed. This means the unit will always operate under the same conditions (especially DVDs) each time.

Check List

- Unit is in TV mode, press FM/TV.

"AUDIO" selections

To select the audio soundtrack language. (Factory preset: English)

English/Spanish/French/Japanese

Original: Original disc language

OTHER **:** Other language selection*¹

"SUBTITLE" selections

To select the subtitle language. (Factory preset: AUTO)

AUTO: Same language selected for "AUDIO"

- If language set for "AUDIO" is used in playback, subtitles will not appear.
- If another language is used during playback, the subtitles will appear in the language selected at "AUDIO" setup.

English/Spanish/French/Japanese

OTHER **:** Other language selection*¹

"MENUS" selections

(Factory preset: English)

To select the language used in title menus or DVD menus.

English/Spanish/French/Japanese

OTHER **:** Other language selection*¹

To enter **OTHER ****** code number, Press **NUMBER** keys (Please refer to language codes on page 51).

To make corrections, press **◀** repeatedly to delete language code number, and correct.

*¹ If the selected language is not offered, the original disc language is selected.

*Important: If a remote control button does not work when pressed, press the FM/TV, DVD button on the remote and try the button again.

AUDIO OUTPUT

Select the digital output to be output from the optical digital audio output connector of the unit.

1 Do steps 1 and 2 on page 48.



- 1) Press ▲▼ to select "AUDIO OUTPUT."
- 2) Press SET to display screen.

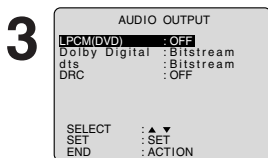

- 1) Press ▲▼ to select an item.
- 2) Press SET repeatedly for output. (See below.)

■ "LPCM (DVD)" selections

- OFF:** Linear PCM of less than 48 kHz/16 bit is output. When playing DVDs recorded in linear PCM of over 48 kHz/20 bit, no digital audio is output. (Factory preset)
- PCM:** When playing DVDs recorded in linear PCM of 48 kHz/20 bit/24 bit or more, digital audio converted to 44.1 kHz/16 bit or 48 kHz/16 bit is output. (Digital output of PCM audio is restricted to 48 kHz/16 bit or below for copyright protection.)

■ "Dolby Digital" selections

- Bitstream:** Dolby Digital bitstream (1ch-5.1ch) is output. (Factory preset)
- PCM:** When you have connected a amplifier that doesn't have a built-in Dolby Digital decoder.

■ "dts" selections

- Bitstream:** dts bitstream is output. (Factory preset)
- PCM:** When you have connected a amplifier that doesn't have a built-in dts decoder.

■ "DRC (Dynamic Range Compression)" selections

- OFF:** Normal audio range is selected. (Factory preset)
- ON:** For dynamic sound even at low volume, this is useful for late-night listening. [Dolby Digital DVDs only].

4 Press ACTION to redisplay DVD MAIN MENU and go to step 2 to setup another item. Or, press ACTION three times to exit.

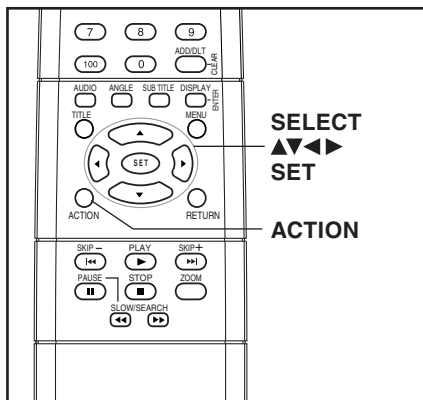

Type of amplifier to be connected	Recommended setting		
	LPCM (DVD)	Dolby Digital	dts
No amplifier is connected			
AV amplifier without Dolby Digital/dts decoder	PCM	PCM*1	PCM*1
AV amplifier including Dolby Digital decoder	PCM	Bitstream	PCM
AV amplifier including Dolby Digital/dts decoder	PCM	Bitstream	Bitstream*2

- Make settings according to amplifier connected to optical audio output as shown in above table.

*1 When connecting an amplifier (with an optical digital input connector) which does not contain the Dolby Digital or dts decoder, be sure to select "PCM." If "Bitstream" is selected, starting DVD play may cause such a high level of noise as to be harmful to your ears and damage the speakers.

*2 When a dts decoder is connected, please select "Bitstream" in "dts." If "PCM" is selected, there will be stereo sound.

Settings for DVD Operation (continued)

STILL MODE

Set to reduce jitter in a displayed still picture or a motion picture.

1 Do steps 1 and 2 on page 48.

2

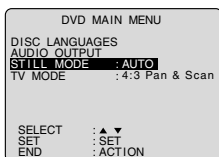

- 1) Press ▲▼* to select "STILL MODE."
- 2) Press SET repeatedly for mode. (See below)

AUTO: "FIELD" (Field still) or "FRAME" (Frame still) is automatically selected during the still mode. (Factory preset)

FIELD: "FIELD" (Field still) is always selected. This setting will reduce jitter when compared with "AUTO" on some discs.

FRAME: "FRAME" (Frame still) is always selected. Some texts and fine patterns will be seen clearly when compared with "AUTO" on some discs.

3 Press ACTION twice to exit this mode.

Selecting TV MODE

Set the screen display style for widescreen video material playback.

a Do steps 1 and 2 on page 48.

b

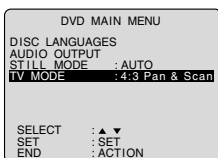

- 1) Press ▲▼ to select "TV MODE."
- 2) Press SET repeatedly for mode. (See below.)

4:3 Pan & Scan : Widescreen video data is played in Pan & Scan style (left and right of screen is trimmed.)

- Video data not formatted in Pan & Scan will play in letterbox style.

4:3 Letterbox : Widescreen video data is played in Letterbox style (top and bottom of screen has black margin).

c Press ACTION twice to exit this mode.

*Important:

If a remote control button does not work when pressed, press the DVD button on the remote and try the button again.

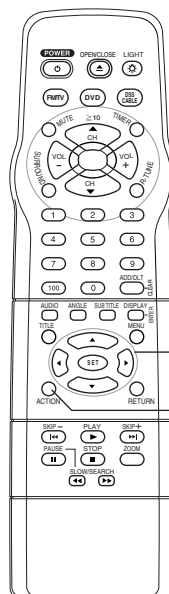

Example

4:3 Pan & Scan (Factory preset)

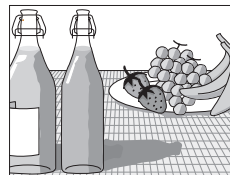

4:3 Letterbox

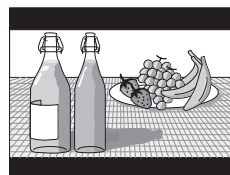

Language Code List

Enter the appropriate code number for the initial settings "AUDIO," "SUBTITLE" and/or "MENUS" (see page 48).

Code	Language
6565	Afar
6566	Abkhazian
6570	Afrikaans
6577	Ameharic
6582	Arabic
6583	Assamese
6588	Aymara
6590	Azerbaijani
6665	Bashkir
6669	Byelorussian
6671	Bulgarian
6672	Bihari
6678	Bengali; Bangla
6679	Tibetan
6682	Breton
6765	Catalan
6779	Corsican
6783	Czech
6789	Welsh
6865	Danish
6869	German
6890	Bhutani
6976	Greek
6978	English
6979	Esperanto
6983	Spanish
6984	Estonian
6985	Basque
7065	Persian
7073	Finnish
7074	Fiji

Code	Language
7079	Faroese
7082	French
7089	Frisian
7165	Irish
7168	Scots Gaelic
7176	Galician
7178	Guarani
7185	Gujarati
7265	Hausa
7273	Hindi
7282	Croatian
7285	Hungarian
7289	Armenian
7365	Interlingua
7378	Indonesian
7383	Icelandic
7384	Italian
7387	Hebrew
7465	Japanese
7473	Yiddish
7487	Javanese
7565	Georgian
7575	Kazakh
7576	Greenlandic
7577	Cambodian
7578	Kannada
7579	Korean
7583	Kashmiri
7585	Kurdish
7589	Kirghiz
7665	Latin

Code	Language
7678	Lingala
7679	Laothian
7684	Lithuanian
7686	Latvian, Lettish
7771	Malagasy
7773	Maori
7775	Macedonian
7776	Malayalam
7778	Mongolian
7779	Moldavian
7782	Marathi
7783	Malay
7784	Maltese
7789	Burmese
7865	Nauru
7869	Nepali
7876	Dutch
7879	Norwegian
7982	Oriya
8065	Panjabi
8076	Polish
8083	Pashto, Pushto
8084	Portuguese
8185	Quechua
8277	Rhaeto-Romance
8279	Romanian
8285	Russian
8365	Sanskrit
8368	Sindhi
8372	Serbo-Croatian
8373	Singhalese

Code	Language
8375	Slovak
8376	Slovenian
8377	Samoan
8378	Shona
8379	Somali
8381	Albanian
8382	Serbian
8385	Sundanese
8386	Swedish
8387	Swahili
8465	Tamil
8469	Telugu
8471	Tajik
8472	Thai
8473	Tigrinya
8475	Turkmen
8476	Tagalog
8479	Tonga
8482	Turkish
8484	Tatar
8487	Twi
8575	Ukrainian
8582	Urdu
8590	Uzbek
8673	Vietnamese
8679	Volapük
8779	Wolof
8872	Xhosa
8979	Yoruba
9072	Chinese
9085	Zulu

Before Requesting Service

Check the following points once again if you are having trouble with your unit.

Power	Correction
No power...	<ul style="list-style-type: none"> • Completely insert Power Plug into an AC outlet. • Set POWER button to ON.
Power turns itself off...	<ul style="list-style-type: none"> • Auto power-off (shut off) occurs after about 5 min. in DVD mode with no operation, or if there is no broadcast signal in TV mode. Turn the power back on. (P. 17, 28)
Monitor	Correction
No picture or sound...	<ul style="list-style-type: none"> • Make sure your antenna system (TV or CABLE), is correctly set. (P. 10) • Completely insert Power Plug into an AC outlet. • Set POWER button to ON.
Poor picture with normal sound...	<ul style="list-style-type: none"> • Adjust BRIGHTNESS, SHARPNESS, and PICTURE controls in the SET UP Video Adjustment. (P. 35)
Poor sound with normal picture...	<ul style="list-style-type: none"> • Adjust VOLUME control. (P. 18)
Poor TV reception...	<ul style="list-style-type: none"> • Adjust SHARPNESS and PICTURE controls in the SET UP Video Adjustment. (P. 35)
No color or poor color...	<ul style="list-style-type: none"> • Adjust TINT and COLOR controls in the SET UP Video Adjustment. (P. 35)
Ghost (multiple) images...	<ul style="list-style-type: none"> • Install a directional antenna.
TV programs cannot be watched...	<ul style="list-style-type: none"> • Make sure the selected channel is in unit's memory. (P. 12)
Remote Control	Correction
Unit cannot be controlled...	<ul style="list-style-type: none"> • Aim Remote directly at the remote sensor on the unit. (P. 9) • Avoid any object blocking signal path. • Inspect the remote batteries. (P. 4) • Exposing unit remote sensor to direct fluorescent or outdoor light may cause signal interference.
ACTION, SELECT, SET POWER, etc. buttons cannot be selected...	<ul style="list-style-type: none"> • Press FM/TV for TV mode. (P. 26) • Press DVD for DVD mode. (P. 26) • Press FM/TV for FM mode. (P. 26) • Check remote batteries.

DVD/Video CD/ CD	Correction
Play fails to start even when PLAY is pressed...	<ul style="list-style-type: none"> • This unit cannot play discs other than DVDs, Video CDs and CDs. • The disc may be dirty and require cleaning.
Play starts but then stops immediately...	<ul style="list-style-type: none"> • Be sure disc is installed with label side up.
Picture is distorted during rapid advance or rapid reverse...	<ul style="list-style-type: none"> • The picture will be somewhat distorted at times: this is normal.
No Forward/Reverse search play...	<ul style="list-style-type: none"> • Some discs may have sections which prohibit Forward/Reverse search. (P. 17)
Play does not start even when title is selected...	<ul style="list-style-type: none"> • Confirm the "DVD LOCK" setting. (P. 47)
Audio soundtrack and/or subtitle language is not the one selected at the initial settings...	<ul style="list-style-type: none"> • If the audio soundtrack and/or subtitle language selected at DVD initial settings does not exist on the disc, it will not be accessible.
No subtitles...	<ul style="list-style-type: none"> • Subtitles appear only when available on disc. • Select "ON" at the "Subtitle language" section (P. 36) to display subtitles.
Alternative audio soundtrack (or subtitle) language cannot be selected...	<ul style="list-style-type: none"> • Alternative language cannot be selected with discs which do not contain more than one language. • For some discs, alternative language cannot be selected with the AUDIO or SUB TITLE button. Try selecting it from the DVD MAIN MENU if available.
Angle cannot be changed...	<ul style="list-style-type: none"> • This function is dependent on software availability. Even if disc has multiple angles, they may be recorded for specific scenes only (ANGLE Indicator on unit lights up). (P. 37)
Miscellaneous	Correction
The disc cannot be removed...	<ul style="list-style-type: none"> • First, unplug unit. Then, prepare a rigid wire (e.g. an extended paper clip, etc.) and, applying moderate force, insert it straight into the hole at the base of the tray. The tray will eject a little. Now, pull the tray all the way out and remove the disc. (P. 7)

If you cannot resolve the problem, please call the Customer Satisfaction Center for product assistance at 1-800-211-PANA(7262).

To locate an authorized servicenter call toll free 1-800-211-PANA(7262) or send e-mail to : consumerproducts@panasonic.com.

Warning and Instruction Displays

These displays will alert you of a missed operation or provide further instructions.

OSD	Caution
PLEASE SET CLOCK BEFORE TIMER SETTING	If you attempt to set the On-Timer and the Clock is not set... (P.12)
PLEASE CHECK THE DISC, AND FOR STAINS OR SCRATCHES ON DISC	If you press PLAY, or the unit reads data from a stained or scratched disc in DVD mode. Also, if the type of disc is other than DVD, Video CD or CD... (P.6)
THIS DISC MAY NOT BE PLAYED IN YOUR REGION	Playback of a disc with different region number was attempted. Only discs marked region "1," "ALL," or those that include "1" are playable on this unit. (P.3)
THIS TYPE OF DISC CANNOT BE PLAYED. PLEASE INSERT A DIFFERENT DISC	An unusable disc is inserted in the unit. (P.6)
CANNOT PLAY THIS FILE	This file format cannot be played. (Appears during MP3/WMA/JPEG file playback)(P.44)
THIS FILE IS PROTECTED	This file is copyright protected and cannot be played back. (Playback is prohibited.)(P.44)

Spanish Quick Use Guide/Guía para rápida consulta

Conecte por favor todas las conexiones del cable o de la antena antes de energizar los aparatos.

Conectando

■ Conexión para Ant./Cable

Conecte Ant./Cable a la entrada de antena de la TV (VHF/UHF).

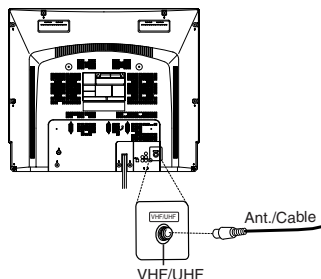

■ Conexión para Sistema Digital de Satelite (DSS)/Convertidor de cable

Conecte la salida del convertidor de cable a la entrada "VHF/UHF" con el RF cable.

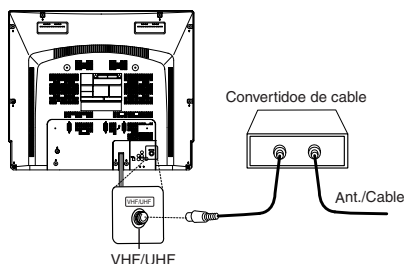

Realizando Configuración Inicial

Presione FM/TV para la modalidad TV.

1 Conecte el cable electrico de la unidad en el enchufe de pared de la CA.

2 Encienda la TV mediante el control o directamente en la unidad. La unidad inicia la busqueda de canales y ajusta el tiempo automaticamente.

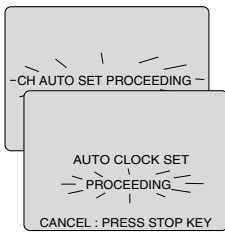

- Si usa convertidor de cable, enciendala y seleccione el Servicio Publico de Canales de Television (PBS) en su horario de uso o tiempo de su zona. Si utiliza receptor DSS este debe de estar apagado.

3 2/6/2003 THU 12:00PM
DST: ON
SETTING : CH 10
AUTO CLOCK SET
COMPLETED

Selecciones se realizaran automaticamente, cuando la configuracion termine la pantalla siguiente aparecera.

AUTO CLOCK SET
IS INCOMPLETE
PLEASE SET CLOCK BY
PRESSING ACTION KEY

- Si "AUTO CLOCK SET IS INCOMPLETE" aparece en pantalla, coloque el tiempo usando el procedimiento manual (MANUAL CLOCK SET), vealo enseguida.

Nota

- Los botones de funciones son inoperantes durante la Configuración inicial.
- Dependiendo de las condiciones, puede que el Ajuste automático del reloj tarde más de 30 minutos. En ese caso, pulse STOP para detener la configuración y realice los ajustes manualmente. (Vea la p.12-13 de Libro de operaciones avanzadas).

Ajuste Manual del Reloj

Si el ajuste automático del reloj no se ha completado, ajuste el reloj manualmente de la siguiente manera.

- 1 Presione ACTION** en el control remoto para visualizar la pantalla del menú RELOJ.
- 2 Presione ▲▼** para seleccionar el mes y **SET** para colocarlo. De la misma forma, seleccione y ajuste la fecha, año, hora y DST (Hora de Verano).
- 3 Presione dos veces la tecla ACTION** para poner el RELOJ en marcha y salir.

Ajustar de nuevo el reloj

- 1 Presione ACTION** para visualizar el menú.

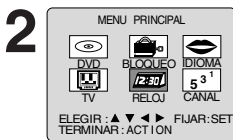

Presione ▲▼◀▶ para seleccionar "RELOJ," y luego **Presione SET**.

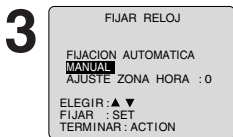

Presione ▲▼ para seleccionar "MANUAL" y luego **presione SET**.



Presione ▲▼ y SET para seleccionar y ajustar la hora y la fecha.

- 5 Presione ACTION dos veces** para que el reloj comience a funcionar y salir de este modo.

Operaciones básicas del DVD

1 Presione **POWER** en el control remoto o el aparato y luego el boton DVD.

2 Introducir un disco.

- 1) Presione **OPEN/CLOSE**.
- 2) Ponga un disco en la bandeja de disco.
 - Sujete el disco sin tocar ninguna de sus superficies, póngalo con el lado donde esté impreso el título hacia arriba, alinéelo con las guías y póngalo en su posición apropiada.
Disco de 3" (8 cm) Disco de 5" (12 cm)

3 Presione **PLAY** para iniciar la reproducción. La bandeja del disco se cierra automáticamente.

- Si está usando un DVD interactivo (Interactive DVD) o un Video CD con control de reproducción (playback control) y aparece un menú de títulos (TITLE MENU) en la pantalla, siga al paso 4.

4 1) Presione **▲▼◀▶** o las teclas numéricas para seleccionar el artículo deseado.
2) Presione **SET** para la reproducción. Si usa las teclas numéricas, la reproducción comienza automáticamente.

5 Presione **STOP** para parar la reproducción.

6 Presione **OPEN/CLOSE** para expulsar el disco.

■ Para buscar una escena en particular **Búsqueda hacia adelante**
Presione **SLOW/SEARCH ▶▶** en el modo de reproducción.

Búsqueda hacia atrás →

Presione **SLOW/SEARCH ◀◀** en el modo de reproducción. (Para liberar, presione **PLAY**)

■ Para saltar un capítulo o una pista **Salto hacia adelante**

Presione **SKIP+ ▶▶|** en el modo de reproducción. Un capítulo (DVD) o una pista (Video CD/CD) se salta cada vez que se oprime la tecla.

Salto hacia atrás →

Presione **SKIP- |◀◀** en el modo de reproducción.

■ Para ver una imagen fija

Presione **PAUSE** durante la reproducción. (Para liberar, presione **PLAY**)

■ Para ver imágenes cuadro a cuadro (DVD/Video CD)

Presione **PAUSE** en el modo de imagen fija.

La imagen avanza un cuadro cada vez que presiona la tecla. (Para volver a la reproducción normal, presione **PLAY**.)

■ Para ver en cámara lenta (DVD/Video CD)

Presione **SLOW/SEARCH ▶▶** o **SLOW/SEARCH ◀◀** en el modo de imagen fija. (Para liberar, presione **PLAY**)

Cambio del idioma de subtítulos [DVD solamente]

El idioma de los subtítulos seleccionado al hacer las fijaciones iniciales se puede cambiar por otro idioma diferente, si éste se encuentra disponible.



Presione **SUBTITLE** durante la reproducción.

- Cuando no haya subtítulos grabados, " " se visualizará en lugar del número de idioma.



- 1) Presione **▲▼** para seleccionar el idioma deseado.
- 2) Presione **▶** (o **◀**) para seleccionar "ACTIVO" o "INACTIVO."

Cambio del idioma de la pista de sonido [DVD solamente]

El idioma de la pista de sonido seleccionado al hacer las fijaciones iniciales se puede cambiar por otro idioma diferente, si éste se encuentra disponible.



Presione **AUDIO** durante la reproducción para visualizar la pantalla **AUDIO**.



Presione **▲▼** para seleccionar el idioma deseado.

Visión desde otro ángulo [DVD solamente]

Algunos discos DVD tienen escenas que han sido filmadas simultáneamente desde un número de ángulos diferentes. Con estos discos, la misma escena podrá verse desde cada uno de estos ángulos diferentes utilizando el botón ANGLE.

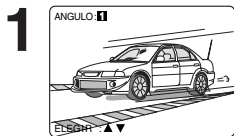

Presione ANGLE durante la reproducción para visualizar la pantalla de ángulo.

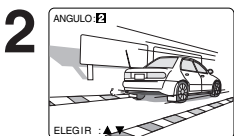

Presione ▲▼ para seleccionar el ángulo deseado.

Selección de vocal para los discos de Karaoke [DVD/Video CD]

1 Presione AUDIO durante la reproducción para visualizar la pantalla AUDIO.

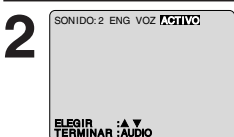

- 1) **Presione ▲▼** (o ◀▶) para seleccionar el ajuste deseado.
- 2) **Presione ▶** (o ◀) para ajustar. (DVD solamente)

- DVD Karaoke (1 vocal)
VOCAL ON→VOCAL OFF
- DVD Karaoke (2 vocales)
VOCAL V1→VOCAL V2→VOCAL V1+V2→VOCAL OFF
- Video CD
LR→L→R

Ampliación de la imagen [DVD solamente]

Durante la reproducción de un DVD, puede ampliar la imagen seleccionando la relación de zoom usando el botón ZOOM mediante control remoto.

Seleccione el tamaño de la imagen.

Presione ZOOM repetidamente para cambiar el tamaño de la imagen como se indica a continuación:

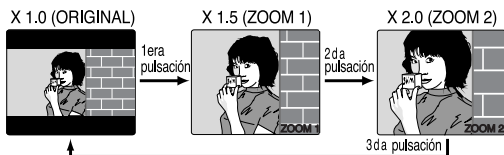

■ Use los botones ▲, ▼, ◀ y ▶ para desplazar la posición hacia arriba, hacia abajo, hacia la izquierda o hacia la derecha.

Utilización de un menú de títulos [DVD solamente]

Algunos discos con películas, por ejemplo, vienen con dos o más títulos. Si el disco tiene un menú de títulos grabados, el botón TITLE podrá utilizarse para seleccionar el título de la película.

1 Presione TITLE durante la reproducción. Ahora se visualiza una lista de los títulos del disco.

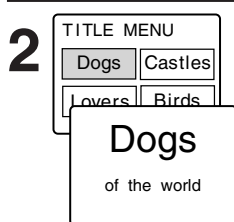

- 1) **Presione ▲▼◀▶** o las teclas numéricas para seleccionar el título deseado.
- 2) **Presione SET** o **PLAY**.

Utilización de un menu de DVD [DVD solamente]

Algunos discos DVD tienen estructuras únicas de menús llamadas menús DVD. Por ejemplo, los DVDs programados con un contenido complejo proporcionan menús guía, y los grabados con varios idiomas proporcionan menús para audio e idiomas de subtítulos. Aunque los contenidos de los menús DVD y la operación cambian de disco a disco, a continuación se explica la operación básica cuando se utiliza esta característica.

1 Presione MENU durante la reproducción. El menú de DVD introducido en el disco se visualiza ahora.

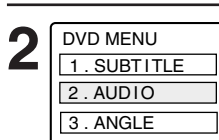

- 1) **Presione ▲▼◀▶** o las teclas numéricas para seleccionar el artículo deseado.
- 2) **Presione SET** o **PLAY**.

Reproducción programada [Vídeo CD/CD]

Puede usted programar pistas específicas y el orden de reproducción.

- 1) Presione **ACTION** en el modo paro (STOP) para visualizar MAIN MENU.



- 1) Presione $\blacktriangle\blacktriangledown\blacktriangleleft\blacktriangleright$ para seleccionar "DVD."
- 2) Presione **SET** para visualizar.



- 1) Presione $\blacktriangle\blacktriangledown$ para seleccionar "MODO DE REPRODUCCION."
- 2) Presione **SET** para visualizar.



- 1) Presione $\blacktriangle\blacktriangledown$ para seleccionar "REPRODUCCION DE PROGRAMAS."
- 2) Presione **SET** para visualizar.



- 1) Presione $\blacktriangle\blacktriangledown\blacktriangleleft\blacktriangleright$ para seleccionar el número de la pista deseada. (Se visualizan los números de la pista del disco).
- 2) Presione **SET** para seleccionar.
 - Repita el paso 5 para seleccionar otra pista.
 - La pista seleccionada se añade a la parte derecha.



- 1) Presione $\blacktriangle\blacktriangledown\blacktriangleleft\blacktriangleright$ para seleccionar "INICIAR."
- 2) Presione **SET**.
 - La reproducción comienza en la secuencia programada.
 - Para cancelar, presione STOP durante la reproducción y luego presione CLEAR.

Reproducción arbitraria [Vídeo CD/CD]

Las pistas se reproducen de forma arbitraria.

- 1) Repita los pasos 1-3 de la "Reproducción programa".



- 1) Presione $\blacktriangle\blacktriangledown$ para seleccionar "REPRODUCCION ALEATORIA."
- 2) Presione **SET**.
 - Comienza la reproducción arbitraria.
 - Para cancelar, presione STOP durante la reproducción y luego presione CLEAR.

Funcionamiento del DVD utilizando visualizaciones en pantalla

Cuando se presiona DISPLAY, la visualización en pantalla muestra la información del disco (título / capítulo / número de lista, tiempo transcurrido de reproducción, audio / idioma del subtítulo, y ángulo) e información (repetir la reproducción, modo reproducción, Karaoke vocal encendido / apagado, etc.).

1 Presione **DISPLAY** en el modo reproducción o parada para visualizar en pantalla.

- Cada vez que se presione **DISPLAY**, la visualización en pantalla cambia como se muestra a continuación.

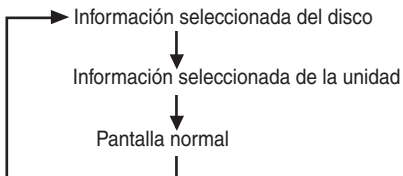

2 1) Presione **▲▼** (o **◀▶**) para seleccionar el artículo deseado.
2) Presione **SET** para colocar.

3 <Ejemplo de DVD>

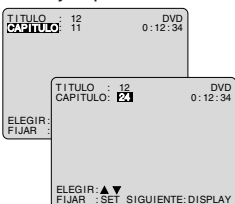

- 1) Presione **▲▼** para seleccionar el ajuste deseado.
2) Presione **SET** para colocar.

<Ejemplo de Vídeo CD>



Para volver a la pantalla normal, presione repetidamente **CLEAR** o **DISPLAY**.

Fijaciones iniciales

1 Presione **ACTION** en el modo de paro (STOP) para visualizar MAIN MENU.

2 1) Presione **▲▼◀▶** para seleccionar "DVD."
2) Presione **SET** para visualizar.

3 1) Presione **st** para seleccionar el artículo deseado.
2) Presione **SET**.

IDIOMAS DEL DISCO

Todos los idiomas ofrecidos en el disco pueden ser ajustados. Si el idioma ajustado no es ofrecido en el disco, se seleccionará el idioma original del disco.

SALIDA DE AUDIO

Puede usted ajustar la salida audio procedente de la terminal de salida audio digital.

DETENER RASTREO

Para seleccionar "CAMPO" o "CUADRO" para prevenir inestabilidad o para permitir ver textos pequeños o patrones finos claramente en el modo de imagen fija.

4 : 3 PREFERENCIA

Para seleccionar si el material del vídeo para pantalla ancha será vuelto a reproducir en el estilo Pan&Scan o en el estilo Letterbox en la pantalla.

4 1) Presione **st** para seleccionar el artículo deseado.
2) Presione **SET**.

5 Volver a visualizar el menú de DVD para continuar el ajuste.
Presione **ACTION** y pase al paso 3 para ajustar otro artículo o, para salir, presione **ACTION** tres veces.

Selección de IDIOMAS DEL DISCO [DVD solamente]

Seleccione "AUDIO"

Inglés/Español/Francés/Japones: (Fijación de fábrica : inglés)

Original : Se seleccionará el idioma original de cada disco.

OTRO **** : Se puede seleccionar el otro idioma.

Seleccione "SUBTITULO"

AUTO : Se seleccionará el mismo que fue seleccionado en la preparación de "AUDIO". (Fijación de fábrica)

- Si el idioma seleccionado en la preparación de "AUDIO" se utiliza durante la reproducción, los subtítulos no aparecerán.
- Si se utiliza otro idioma durante la reproducción, los subtítulos aparecerán en el idioma seleccionado en la preparación de "AUDIO"

Inglés/Español/Francés/Japones

OTRO **** : Se puede seleccionar el otro idioma.

Seleccione "MENU"

Inglés/Español/Francés/Japones : (Fijación de fábrica : inglés)

OTRO **** : Se puede seleccionar el otro idioma.

Selección de 4 : 3 PREFERENCIA

4:3 Pan&Scan : Datos de la pantalla ancha de vídeo son reproducidos en el estilo Pan & Scan (la parte derecha e izquierda de la pantalla son recortadas). (Fijación de fábrica)

- Datos de vídeo no formateados en Pan & Scan serán reproducidos en el estilo letterbox.

4:3 Letterbox : Datos de la pantalla ancha de vídeo son reproducidos en el estilo Letterbox (la parte de arriba y abajo de la pantalla tienen un margen negro).

Selección de DETENER RASTREO

- AUTO :** Durante el modo de imagen fija se seleccionarán automáticamente "Campo fijo" o "Cuadro fijo" (Fijación de fábrica)
- CAMPO :** Seleccione este ajuste cuando ocurra "distorsión" en las imágenes, incluso cuando se haya seleccionado "AUTO".
- CUADRO :** "Cuadro fijo" esta siempre seleccionado. Se utiliza cuando no se puedan ver claramente textos pequeño o patrones finos incluso cuando esté seleccionado "AUTO".

Funcionamiento de la ejecución de MP3/WMA/JPEG

Puede utilizar esta unidad para reproducir audio de formato MP3/WMA/JPEG, grabado para uso personal con una computadora, etc., en un CD-ROM o CD-RW.

La ejecución puede no tener lugar en algunos casos, debido a las condiciones de la grabación.

1 Presione **POWER** en el control remoto o unidad.

2 Presione **OPEN/CLOSE** y a continuación coloque un disco MP3/WMA/JPEG en la bandeja de discos.
Presione **OPEN/CLOSE** para cerrarla.

3 Se visualizará el MENU MP3/WMA/JPEG y la ejecución se iniciará automáticamente.
(Se visualizará el directorio del CD.)

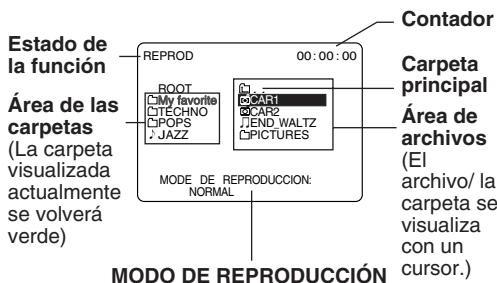

■Ejecución MP3/WMA/JPEG (Durante el modo STOP)

Presione **▲▼** para seleccionar un archivo MP3/WMA (**J / A**) o un archivo JPEG (**☺**), y presione **SET** o **PLAY**.

• MP3/WMA

Búsqueda hacia adelante/hacia atrás

→Presione **SLOW/SEARCH ►►** o

SLOW/SEARCH ◄◄ durante la ejecución.

Salto de Pista hacia adelante/hacia atrás

→Presione **SKIP+ ►►|** o **SKIP-|◄◄** durante la ejecución.

• JPEG

Búsqueda siguiente/anterior

→Presione **SKIP+ ►►|** o **SKIP-|◄◄**.

Inicie la muestra-diaPOSITIVA

→Presione **SLOW/SEARCH ►►** o **SLOW/SEARCH ◄◄**

Ampliando una imagen →Presione **ZOOM**.

Rotando una imagen →Presione **ANGLE**.

Presione STOP para detener la operación descrita arriba.

■Selección MODO DE REPRODUCCION (Durante el modo STOP)

Presione **◄►** para mover el cursor a MODO DE REPRODUCCION, y Presione **▲▼** para seleccionar el MODO DE REPRODUCCIÓN deseado.

[MODO DE REPRODUCCIÓN]

NORMAL: Todos los archivos se reproducen sólo una vez

REPETICION DE UNA MUSIC:

El archivo seleccionado se reproduce repetidamente.

REPETICION DE UN ARCHIVO:

Los archivos que se encuentran en la carpeta seleccionada se reproducen repetidamente.

REPETICION DEL DISCO:

Todos los archivos se reproducen repetidamente.

4 Presione **ACTION** para regresar al DVD MAIN PRINCIPAL.

🎵: Archivo MP3 **🎵:** Archivo WMA **📷:** Archivo JPEG

📁: Carpeta **📁:** Carpeta principal

Limited Warranty

PANASONIC CONSUMER ELECTRONICS COMPANY, DIVISION OF MATSUSHITA ELECTRIC CORPORATION OF AMERICA
One Panasonic Way Secaucus, New Jersey 07094

PANASONIC SALES COMPANY, DIVISION OF MATSUSHITA ELECTRIC OF PUERTO RICO, INC., AVE. 65 de Infantería, Km. 9.5 San Gabriel Industrial Park, Carolina, Puerto Rico 00985

Panasonic/Quasar Video Products Limited Warranty

Limited Warranty Coverage

If your product does not work properly because of a defect in materials or workmanship, Panasonic Consumer Electronics Company or Panasonic Sales Company (collectively referred to as "the warrantor") will, for the length of the period indicated on the chart below, which starts with the date of original purchase ("warranty period"), at its option either (a) repair your product with new or refurbished parts, or (b) replace it with a new or a refurbished product. The decision to repair or replace will be made by the warrantor.

Product	Parts	Labor	Service	Contact Number
Camcorder	One (1) Year (except CCD Image Sensor)	Ninety (90) Days	Carry-In or Mail-In	1-800-211-PANA(7262)
	CCD Image Sensor - 6 (Six) Months	Ninety (90) Days		
DVD/VCR Deck, A/V Mixer	One (1) Year	Ninety (90) Days	Carry-In or Mail-In	1-800-211-PANA(7262)
TV/VCR, TV/DVD, TV/DVD/VCR Combination	One (1) Year (except CRT) CRT - Two (2) Years	Ninety (90) Days Ninety (90) Days	Carry-In: 21" CRT and Smaller In-Home or Carry-In: 22" CRT and Larger	1-800-211-PANA(7262)
TV/HDR Combination	One (1) Year (except CRT) CRT - Two (2) Years	Ninety (90) Days Ninety (90) Days	In-Home or Carry-In	1-888-843-9788
Rechargeable Batteries (in exchange for defective item)	Ten (10) Days	Not Applicable	Carry-In or Mail-In	1-800-211-PANA(7262)
Tape (in exchange for defective item)	Five (5) Days	Not Applicable	Carry-In or Mail-In	1-800-211-PANA(7262)
Memory Cards (in exchange for defective item)	Ninety (90) Days	Not Applicable	Carry-In or Mail-In	1-800-211-PANA(7262)

During the "Labor" warranty period there will be no charge for labor. During the "Parts" warranty period, there will be no charge for parts. You must carry-in or mail-in your product or arrange for in-home service, as applicable, during the warranty period.

If non-rechargeable batteries are included, they are not warranted. This warranty only applies to products purchased and serviced in the United States or Puerto Rico. This warranty is extended only to the original purchaser of a new product which was not sold "as is." A purchase receipt or other proof of the original purchase date is required for warranty service.

Carry-In, Mail-in or In-Home Service

For Carry-In, Mail-In or In-Home Service (as applicable) in the United States call toll free contact number listed above or visit Panasonic Web Site: <http://www.panasonic.com>

For assistance in Puerto Rico call Panasonic Sales Company (787)-750-4300 or fax (787)-768-2910.

In-Home service, if applicable, requires clear, complete and easy access to the product by the authorized servicer and does not include removal or re-installation of an installed product. It is possible that certain in-home repairs will not be completed in-home, but will require that the product, or parts of the product, be removed for shop diagnosis and/or repair and then returned.

Limited Warranty Limits And Exclusions

This warranty ONLY COVERS failures due to defects in materials or workmanship, and DOES NOT COVER normal wear and tear or cosmetic damage, nor does it cover markings or retained images on the picture tube resulting from viewing fixed images (including, among other things, letterbox pictures on standard 4:3 screen TV's, or non-expanded standard 4:3 pictures on wide screen TV's, or onscreen data in a stationary and fixed location). The warranty ALSO DOES NOT COVER damages which occurred in shipment, or failures which are caused by products not supplied by the warrantor, or failures which result from accidents, misuse, abuse, neglect, mishandling, misapplication, alteration, faulty installation, set-up adjustments, misadjustment of consumer controls, improper maintenance, power line surge, lightning damage, modification, or commercial use (such as in a hotel, office, restaurant, or other business), rental use of the product, service by anyone other than a Factory Servicenter or other Authorized Servicer, or damage that is attributable to acts of God.

THERE ARE NO EXPRESS WARRANTIES EXCEPT AS LISTED UNDER "LIMITED WARRANTY COVERAGE." THE WARRANTOR IS NOT LIABLE FOR INCIDENTAL OR CONSEQUENTIAL DAMAGES RESULTING FROM THE USE OF THIS PRODUCT, OR ARISING OUT OF ANY BREACH OF THIS WARRANTY. (As examples, this excludes damages for lost time, cost of having someone remove or re-install an installed unit if applicable, or travel to and from the servicer, loss of media or images, data or other memory or recorded content. The items listed are not exclusive, but are for illustration only.)

ALL EXPRESS AND IMPLIED WARRANTIES, INCLUDING THE WARRANTY OF MERCHANTABILITY, ARE LIMITED TO THE PERIOD OF THE LIMITED WARRANTY.

Some states do not allow the exclusion or limitation of incidental or consequential damages, or limitations on how long an implied warranty lasts, so the exclusions may not apply to you.

This warranty gives you specific legal rights and you may also have other rights which vary from state to state. If a problem with this product develops during or after the warranty period, you may contact your dealer or Servicenter. If the problem is not handled to your satisfaction, then write to the warrantor's Consumer Affairs Department at the addresses listed for the warrantor.

PARTS AND SERVICE (INCLUDING COST OF AN IN-HOME SERVICE CALL, WHERE APPLICABLE) WHICH ARE NOT COVERED BY THIS LIMITED WARRANTY ARE YOUR RESPONSIBILITY.

Customer Services Directory

*For Product Information, Operating Assistance, Literature Request, Dealer Locations, and all Customer Service inquiries please contact:
1-800-211-PANA (7262), Monday-Friday 9 am-9 pm; Saturday-Sunday 10 am-7 pm, EST. or send e-mail : consumerproducts@panasonic.com
For hearing or speech impaired TTY users, TTY : 1-877-833-8855*

Web Site: <http://www.panasonic.com>

You can purchase parts, accessories or locate your nearest servicenter by visiting our Web Site.

Accessory Purchases:

1-800-332-5368 (Customer Orders Only)

For hearing or speech impaired TTY users, TTY : 1-866-605-1277

**Panasonic Services Company 20421 84th Avenue South, Kent, WA 98032
(Monday-Friday 6 am-5 pm; Saturday 6 am-10:30 am, PST)
(Visa, MasterCard, Discover Card, American Express, Check)**

Service in Puerto Rico

*Matsushita Electric of Puerto Rico, Inc. Panasonic Sales Company/
Factory Servicenter:*

*Ave. 65 de Infertería, Km. 9.5, San Gabriel Industrial Park,
Carolina, Puerto Rico 00985*

Phone (787)750-4300 Fax (787)768-2910

As of August 2002

Index

TV

- A** Accessories..... 4
 - AC Power Plug..... 9
 - ACTION button..... 8, 12
 - ADD/HLT/CLEAR button..... 8, 13
 - Audio Adjustment..... 35
 - Audio Auto Gain Control (AGC)..... 34
 - AUDIO button..... 8, 19, 25
 - Audio Connections..... 14-15
 - Audio Features..... 34-35
 - Audio Menu..... 34
 - Audio Mode for FM Radio..... 27
 - Audio Mode for TV Viewing..... 19
 - Audio Mute..... 18
 - Audio/Video Input connector (LINE).... 9
 - Audio Output Connector (L/R)..... 9
 - Auto Operation Functions..... 28
- B** Batteries..... 4
 - Before Requesting Service..... 52-53
 - Before Using..... 4
 - Blocking Message..... 33
 - Blue Screen Display..... 23
 - Broadcast Types..... 19
- C** Cable Box Brand Code Number..... 27
 - Cable Box Universal Remote
 - Control Feature..... 26
 - Caption On Mute..... 21
 - Channel..... 10, 12-13, 23
 - CHANNEL UP/DOWN button..... 8, 18
 - Clock..... 12
 - Closed Caption..... 20-21
 - Connections..... 10
 - Connections, Audio..... 14-15
 - Connections, ANT./Cable..... 10
 - Customer Services Directory..... 63
- D** DISPLAY/ENTER button..... 8, 23, 26
 - DST (Daylight Saving Time)..... 11
- F** FM button..... 8, 24-25
 - FM Radio..... 24-25
 - Front Panel Indicators..... 9
- I** Important Safeguards and Precautions .. 2
 - Information (Unit, Disc)..... 6-7
 - Initial Setup..... 10
 - Indicators on the Front Panel..... 9
 - Input Mode..... 28
- L** Language..... 12
 - Limited Warranty..... 62-63
 - Location of Controls..... 8
- M** MTS Broadcast/TV Stereo System ... 19
 - MUTE button..... 8, 18
- N** NUMBER keys..... 8, 18
- O** 100 Key..... 18
 - On-Screen Display (OSD)..... 23
 - ON-TIMER Indicator..... 9, 22
 - ON-TIMER with Alarm..... 22
- P** Phones..... 18
 - POWER button..... 8, 10
- Q** Quality Picture..... 4
- R** Rapid Tune..... 18
 - R-TUNE button..... 8, 18
 - Remote Control Buttons..... 8
 - Remote Sensor..... 9
 - Remote Warning Feature..... 28
 - Reset Language, Channels, Clock.... 12
 - Reset unit..... 11
- S** Safety Precautions..... 3
 - Secret Code..... 30
 - SELECT/SET button..... 8, 12
 - Sleep Timer..... 22
 - SLEEP TIMER Indicator..... 9, 22
 - Spanish Quick Use Guide..... 55-61
 - Specifications..... 6
 - SURROUND button..... 8, 29
 - Surround Sound..... 29
- T** Table of Contents..... 5
 - Time Zone Adjust..... 13
 - TV Timer Features..... 22
- U** Unit, Front/Rear View..... 9
 - US MOVIES Ratings..... 31
 - US TV PROGRAMS Ratings..... 32
- V** Video Adjustment..... 35
 - Video/Audio Menu..... 34
 - Video/Audio Adjust..... 35
 - Video Menu..... 34
 - V-Chip Control Feature..... 30-33
 - VHF/UHF Antenna Input Terminal..... 9
 - VOLUME UP/DOWN button..... 8, 18
- W** Warning and Instruction Displays..... 54

DVD

- A** ANGLE button 8, 37, 46
 - ANGLE Indicator 9, 37
 - Auto-Power Off function 17
 - AUDIO button 8, 36, 37
 - AUDIO OUTPUT 49
 - Audio soundtrack language (DVD) 36
- B** Basic DVD Operation 16
- C** CLEAR button 8, 39-41
- D** Definition of terms 7
 - Disc Audio attribute 1 type, sampling frequency, bit No..... 36
 - Disc format 6
 - Disc handling 7
 - Disc information screen..... 42
 - DISC LANGUAGES (DVD)..... 48
 - Disc Operation 36-40
 - Disc Tray..... 7, 9, 16
 - DISPLAY 41-43
 - DISPLAY button 8, 41
 - DVD button..... 8, 16
 - DVD Lock Feature (DVD) 47
 - DVD Lock Ratings (DVD) 47
 - DVD menu (DVD) 38
 - DVD Operation using On-Screen ... 41-43
 - DVD Volume Adjust..... 29
- F** Forward/Reverse Chapter/Track skip... 17
 - Forward/Reverse rapid scene search ... 17
 - Frame by Frame picture (DVD/Video CD) 17
- J** JPEG Playback 45-46
- K** Karaoke (DVD/Video CD)..... 37
- L** Language Code List..... 51
- M** MENU button 8, 38
 - MP3 Playback 45
 - Multiple angle viewing (DVD) 37
- O** OPEN/CLOSE button..... 8, 16
 - Optical digital audio output connector 9, 14-15
- P** PAUSE button 8, 17
 - Picture Zoom (DVD)..... 37
 - Play 16
 - Playback control (Video CDs) 17
 - PLAY button 8, 16
 - Program Play (Video CD/CD) 39
 - Program Repeat Play (Video CD/CD) .. 39
- R** Random Play (Video CD/CD)..... 40
 - Region number..... 3
 - Repeat Play 43
 - RESUME function 17
 - RETURN button 8, 16
- S** Settings for DVD Operation 48-50
 - SKIP+ ►►/SKIP- I◀◀... 8, 16-17, 44-46
 - Slow Motion (DVD/Video CD) 17
 - SLOW/SEARCH ►►/◀◀... 8, 16-17, 45-46
 - STILL MODE..... 50
 - Still (Pause) Picture..... 17
 - Subtitle language (DVD) 36
 - SURROUND button 8, 29
- T** TV MODE..... 50
 - Title menu (DVD)..... 38
- U** Unit information screen (Unit) 43
- V** V.S.S. (Virtual Surround Sound)..... 29
- W** WMA Playback 45
- Z** ZOOM button 8, 37

NOTES

NOTES

LSQT0670B

Panasonic Consumer Electronics Company,
Division of Matsushita Electric Corporation of America
One Panasonic Way Secaucus, New Jersey 07094

Panasonic Sales Company ("PSC"),
Division of Matsushita Electric of Puerto Rico, Inc.
Ave. 65 de Infantería, Km. 9.5
San Gabriel Industrial Park, Carolina, Puerto Rico 00985



Printed in Indonesia
LSQT0670B
S0303-1033